

LED Lum

Lighting.Simplified



Outdoor Catalogue 2017

PREFACE

LEDLum Lighting Solutions LLP – a venture promoted by Sumeet Malhotra.

LEDLum Lighting Solutions LLP is a futuristic lighting company promoted by the founder of the very popular ABBA Brand. The promoters of this innovative brand have more than 25 years of experience in the world of professional lighting. As a result of the stable and solid corporate and customer focused policy followed during 25 years in this business, we have a thorough knowledge of the requirements of customers in the architectural, retail, industrial and entertainment worlds. The focus is to bring international expertise to the unique demands of the Indian market. Today, we aspire to be leaders in lighting innovation & technology.

We pursue the goal of perfection in the products we make and the way we conduct business. We hold ourselves responsible to our customers and suppliers. We build products that inspire customer confidence and satisfaction.

As a result of our unique modular design structure for a large part of our product portfolio, we are able to offer thousands of product variants within a limited number of product groups. We ensure that architects and designers across the country are always able to find the perfect lighting solution for any lighting project. Many of the products offered by us are patented by our factories.

Besides that, we don't compromise in our approach towards quality. Only the very best components are being used for our products. More than 30000 hours of lifetime for a LED light fixture is only possible if the LED's, the heat sink and the power supply are of a superior quality and we ensure that.

Elements which sets us apart from other brands owners are:

- **INNOVATION:** Over 2000 products, including many high performance and highly reliable ones which can't be found anywhere else.
- **SUSTAINABILITY:** Our Eco-Technology products offer sustainable energy solutions that meet the qualitative needs of the visual environment with the least impact on the physical environment.
- **QUALITY:** We use the best components and manufacturing methods resulting in the highest quality fixtures. For consistency, we use only the most reliable LED chip makers.
- **SERVICE:** Our responsive, personalised customer focus and market expertise represents an oasis of outstanding service in an industry that values it, but frequently doesn't receive it. We are here to offer you the best of services covering all aspects.
- **MARKET EXPERTISE:** Each market has its own unique lighting challenges. We have an experienced staff of sales professionals to assist you with your projects from concept to completion.

If you wish to be part of a generation that positively changed the future of the earth by reducing the energy and maintenance costs of lighting systems by 70-80%, then contact us for a possible distributorship/ dealership anywhere in the country. We will be happy to work together.

Sincerely

Sumeet Malhotra
Chief Executive Officer















INDEX









HI - POWER LED OUTDOOR WALL LIGHT FIXTURES

							
LLO-001	LLO-002	LLO-003	LLO-005	LLO-006	LLO-007	LLO-008	LLO-009
Page No. - 002	Page No. - 002	Page No. - 002	Page No. - 002	Page No. - 003	Page No. - 003	Page No. - 003	Page No. - 003
							
LLO-011	LLO-012	LLO-013	LLO-015	LLO-016	LLO-017	LLO-018	LLO-019
Page No. - 004	Page No. - 004	Page No. - 004	Page No. - 004	Page No. - 005	Page No. - 005	Page No. - 005	Page No. - 005
							
LLO-019A	LLO-020	LLO-021	LLO-023	LLO-025	LLO-028	LLO-030	LLO-031
Page No. - 006	Page No. - 006	Page No. - 006	Page No. - 006	Page No. - 007	Page No. - 007	Page No. - 007	Page No. - 007
							
LLO-032	LLO-033	LLO-034	LLO-035	LLO-080	LLO-081	LLO-082	LLO-084
Page No. - 008	Page No. - 008	Page No. - 008	Page No. - 008	Page No. - 009	Page No. - 009	Page No. - 009	Page No. - 009
							
LLO-085	LLO-086	LLO-087	LLO-089	LLO-090	LLO-091	LLO-092	LLO-093
Page No. - 010	Page No. - 010	Page No. - 010	Page No. - 010	Page No. - 011	Page No. - 011	Page No. - 011	Page No. - 011
							
LLO-096	LLO-098	LLO-099A					
Page No. - 012	Page No. - 012	Page No. - 012					

LED OUTDOOR SURFACE FIXTURES















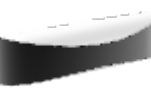

							
LLO-040	LLO-041	LLO-042	LLO-043	LLO-044	LLO-045	LLO-046	LLO-047
Page No. - 014	Page No. - 014	Page No. - 014	Page No. - 014	Page No. - 015	Page No. - 015	Page No. - 015	Page No. - 015
							
LLO-048	LLO-051	LLO-052					
Page No. - 016	Page No. - 016	Page No. - 016					

SMD LED OUTDOOR WALL LIGHT FIXTURES









							
LLO-060	LLO-061	LLO-062	LLO-063	LLO-068	LLO-069	LLO-071	LLO-073
Page No. - 018	Page No. - 018	Page No. - 018	Page No. - 018	Page No. - 019	Page No. - 019	Page No. - 019	Page No. - 020
							
LLO-074							
Page No. - 020							

INDEX





220V AC LED OUTDOOR WALL LIGHT FIXTURES

							
LLO-036	LLO-094	LLO-095	LLO-100	LLO-101	LLO-102	LLO-103	LLO-104
Page No. - 022	Page No. - 022	Page No. - 022	Page No. - 022	Page No. - 023	Page No. - 023	Page No. - 023	Page No. - 023
							
LLO-105	LLO-106	LLO-107	LLO-108	LLO-109	LLO-110	LLO-111	LLO-112
Page No. - 024	Page No. - 024	Page No. - 024	Page No. - 024	Page No. - 025	Page No. - 025	Page No. - 025	Page No. - 025
							
LLO-113							
Page No. - 026							

LED OUTDOOR WALL LIGHT FIXTURES - WHITE BODY

							
LLO-130	LLO-131	LLO-132	LLO-133	LLO-134	LLO-135	LLO-136	LLO-137
Page No. - 028	Page No. - 028	Page No. - 028	Page No. - 028	Page No. - 029	Page No. - 029	Page No. - 029	Page No. - 029
							
LLO-138							
Page No. - 030							

LED INGROUND LIGHT FIXTURES-(WITH IP68 CONNECTORS)

							
LLO-120	LLO-121	LLO-122	LLO-123	LLO-124	LLO-125	LLO-126	LLO-127
Page No. - 032	Page No. - 032	Page No. - 032	Page No. - 032	Page No. - 033	Page No. - 033	Page No. - 033	Page No. - 033
							
LLO-128	LLO-129	LLO-129A					
Page No. - 034	Page No. - 034	Page No. - 034					

LED OUTDOOR RECESSED LIGHT FIXTURES

							
LLO-140	LLO-141	LLO-142	LLO-143	LLO-144	LLO-145	LLO-146	LLO-147
Page No. - 036	Page No. - 036	Page No. - 036	Page No. - 036	Page No. - 037	Page No. - 037	Page No. - 037	Page No. - 037
							
LLO-148	LLO-149	LLO-150	LLO-151	LLO-152	LLO-153	LLO-154	LLO-155
Page No. - 038	Page No. - 038	Page No. - 038	Page No. - 038	Page No. - 039	Page No. - 039	Page No. - 039	Page No. - 039
							
LLO-156	LLO-157						
Page No. - 040	Page No. - 040						

INDEX

LED GARDEN LIGHT FIXTURES SPIKE/BASE - (WITH IP68 CONNECTORS)

							
LLO-160	LLO-161	LLO-162	LLO-163	LLO-164	LLO-165	LLO-166	LLO-167
Page No. - 043	Page No. - 043	Page No. - 043	Page No. - 043	Page No. - 044	Page No. - 044	Page No. - 044	Page No. - 044
							
LLO-168	LLO-169	LLO-170	LLO-171	LLO-172	LLO-173	LLO-174	LLO-175
Page No. - 045	Page No. - 045	Page No. - 045	Page No. - 045	Page No. - 046	Page No. - 046	Page No. - 046	Page No. - 046

LED SWIMMING POOL LIGHT - (WITH IP68 CONNECTORS)



							
LSP-001	LSP-002	LSP-003	LSP-004	LSP-005	LSP-006	LSP-007	LSP-008
Page No. - 048	Page No. - 048	Page No. - 048	Page No. - 048	Page No. - 048	Page No. - 048	Page No. - 048	Page No. - 048
							
LSP-009	LSP-010	LSP-011	LSP-012	LSP-013	LSP-014	LSP-015	LSP-016
Page No. - 049	Page No. - 049	Page No. - 049	Page No. - 049	Page No. - 049	Page No. - 049	Page No. - 049	Page No. - 049
							
LSP-017	LSP-018	LSP-019	LSP-020	LSP-021	LSP-022	LSP-023	LSP-024
Page No. - 050	Page No. - 050	Page No. - 050	Page No. - 050	Page No. - 051	Page No. - 051	Page No. - 051	Page No. - 051
							
LSP-025	LSP-026	LSP-027	LSP-028				
Page No. - 052	Page No. - 052	Page No. - 052	Page No. - 052				

LED SURFACE WALL LIGHT & BOLLARDS

























							
LLO-004	LB-030	LB-031	LLO-010	LB-0100	LB-101	LB-102	LLO-014
Page No. - 055	Page No. - 055	Page No. - 055	Page No. - 056	Page No. - 056	Page No. - 056	Page No. - 056	Page No. - 057
							
LB-058	LB-059	LLO-022	LB-035	LLO-024	LB-046	LLO-026	LB-080
Page No. - 057	Page No. - 057	Page No. - 058	Page No. - 058	Page No. - 059	Page No. - 059	Page No. - 060	Page No. - 060
							
LB-081	LB-082	LLO-027	LB-050	LB-051	LB-052	LLO-029	LB-032
Page No. - 060	Page No. - 060	Page No. - 061	Page No. - 061	Page No. - 061	Page No. - 061	Page No. - 062	Page No. - 062
							
LB-033	LB-034	LLO-037	LB-086	LB-087	LLO-038	LB-083	LB-084
Page No. - 062	Page No. - 062	Page No. - 063	Page No. - 063	Page No. - 063	Page No. - 064	Page No. - 064	Page No. - 064

INDEX

LED SURFACE WALL LIGHT & BOLLARDS

							
LLO-039	LB-085	LLO-083	LB-038	LB-039	LLO-097	LB-056	LB-057
Page No. - 065	Page No. - 065	Page No. - 066	Page No. - 066	Page No. - 066	Page No. - 0067	Page No. - 067	Page No. - 067
							
LLO-099	LLO-088	LB-053	LLO-064	LB-062	LLO-065	LB-060	LB-061
Page No. - 068	Page No. - 098	Page No. - 068	Page No. - 069	Page No. - 069	Page No. - 070	Page No. - 070	Page No. - 070
							
LLO-066	LB-065	LB-066	LLO-067	LB-067	LB-068	LLO-070	LB-072
Page No. - 071	Page No. - 071	Page No. - 071	Page No. - 072	Page No. - 072	Page No. - 072	Page No. - 073	Page No. - 073
							
LB-073	LLO-075	LB-077	LLO-078	LB-079	LLO-076	LB-074	LB-075
Page No. - 073	Page No. - 074	Page No. - 074	Page No. - 074	Page No. - 074	Page No. - 075	Page No. - 075	Page No. - 075
							
LB-076	LLO-077	LB-047	LLO-048	LB-049	LB-036	LB-037	LB-040
Page No. - 075	Page No. - 076	Page No. - 076	Page No. - 076	Page No. - 076	Page No. - 077	Page No. - 077	Page No. - 078
							
LB-041	LB-042	LB-054	LB-043	LB-044	LB-045	LB-063	LB-064
Page No. - 078	Page No. - 079	Page No. - 079	Page No. - 080	Page No. - 080	Page No. - 080	Page No. - 081	Page No. - 081
							
LB-069	LB-070	LB-071	LB-088	LB-096	LB-097	LB-093	LB-094
Page No. - 082	Page No. - 082	Page No. - 082	Page No. - 083	Page No. - 083	Page No. - 083	Page No. - 084	Page No. - 084

E-27 SURFACE WALL LIGHT & BOLLARDS











							
LWL-002	LB-011	LB-012	LWL-003	LB-009	LB-010	LWL-004	LB-013
Page No. - 087	Page No. - 087	Page No. - 087	Page No. - 088	Page No. - 088	Page No. - 088	Page No. - 089	Page No. - 089
							
LB-014	LWL-007	LB-026	LB-027	LB-028	LWL-008	LB-029	LB-029A
Page No. - 089	Page No. - 090	Page No. - 090	Page No. - 090	Page No. - 090	Page No. - 091	Page No. - 091	Page No. - 091
							
LB-029B	LWL-010	LWL-011	LB-089	LB-090	LB-091	LWL-033	LB-007
Page No. - 091	Page No. - 092	Page No. - 092	Page No. - 092	Page No. - 092	Page No. - 092	Page No. - 093	Page No. - 093

INDEX

E-27 SURFACE WALL LIGHT & BOLLARDS

							
LB-008	LWL-035	LB-018	LB-019	LB-020	LWL-036	LB-015	LB-016
Page No. - 093	Page No. - 094	Page No. - 094	Page No. - 094	Page No. - 094	Page No. - 095	Page No. - 095	Page No. - 095
							
LB-017	LWL-037	LB-023	LB-024	LB-025	LB-001	LB-002	LB-004
Page No. - 095	Page No. - 096	Page No. - 096	Page No. - 096	Page No. - 096	Page No. - 097	Page No. - 097	Page No. - 097
							
LB-003	LB-103	LB-104	LB-021	LB-022	LB-005	LB-006	LB-095
Page No. - 097	Page No. - 098	Page No. - 098	Page No. - 099	Page No. - 099	Page No. - 100	Page No. - 100	Page No. - 100
							
LB-099							
Page No. - 100							

POLE LIGHTS

							
LPL-001	LPL-002	LPL-003	LLO-072	LPL-004	LPL-005	LPL-006	LPL-007
Page No. - 102	Page No. - 102	Page No. - 103	Page No. - 104	Page No. - 104	Page No. - 104	Page No. - 105	Page No. - 105
							
LPL-008	LPL-009	LPL-010					
Page No. - 105	Page No. - 106	Page No. - 106					

E-27 OUTDOOR SURFACE WALL LIGHT

							
LWL-001	LWL-005	LWL-006	LWL-009	LWL-012	LWL-013	LWL-014	LWL-015
Page No. - 109	Page No. - 109	Page No. - 109	Page No. - 109	Page No. - 110	Page No. - 110	Page No. - 110	Page No. - 110
							
LWL-016	LWL-017	LWL-020	LWL-021	LWL-022	LWL-023	LWL-024	LWL-025
Page No. - 111	Page No. - 111	Page No. - 111	Page No. - 111	Page No. - 112	Page No. - 112	Page No. - 112	Page No. - 112
							
LWL-026	LWL-027	LWL-028	LWL-029	LWL-030	LWL-031	LWL-032	LWL-034
Page No. - 113	Page No. - 113	Page No. - 113	Page No. - 113	Page No. - 114	Page No. - 114	Page No. - 114	Page No. - 114

INDEX

OUTDOOR GATE LIGHTS



LGL-001

Page No. - 117



LGL-002

Page No. - 117



LGL-003

Page No. - 117



LGL-004

Page No. - 117



LGL-005

Page No. - 118



LGL-006

Page No. - 118

E-27 OUTDOOR BULK HEADS



LBH-001

Page No. - 121



LBH-002

Page No. - 121



LBH-003

Page No. - 121



LBH-004

Page No. - 121



LBH-005

Page No. - 122



LBH-007

Page No. - 122



LBH-008

Page No. - 122



LBH-009

Page No. - 122

E-27 OUTDOOR CONCEALED WALL LIGHTS



LCWL-001

Page No. - 125



LCWL-002

Page No. - 125



LCWL-003

Page No. - 125



LCWL-004

Page No. - 125



LCWL-005

Page No. - 126



LCWL-006

Page No. - 126

GU10 OUTDOOR IN GROUND LIGHTS



LUG-001

Page No. - 128



LUG-002 / 003

Page No. - 128



LUG-004 / 005

Page No. - 128

GU10 GARDEN SPIKE LIGHTS



LGLS-001

Page No. - 130



LGLS-002

Page No. - 130

LED LUM ECO SERIES OUTDOOR LIGHTS



LEO-001

Page No. - 133



LEO-002

Page No. - 133



LEO-003

Page No. - 133



LEO-004

Page No. - 133



LEO-005

Page No. - 134



LEO-006

Page No. - 134



LEO-007

Page No. - 134



LEO-008

Page No. - 134



LEO-009

Page No. - 135



LEO-010

Page No. - 135



LEO-011

Page No. - 135



LEO-012

Page No. - 135



LEO-013

Page No. - 136



LEO-014

Page No. - 136



LEO-015

Page No. - 136



LEO-016

Page No. - 136



LEO-017

Page No. - 137



LEO-018

Page No. - 137



LEO-019

Page No. - 137



LEO-020

Page No. - 137



LEO-021

Page No. - 138



LEO-022

Page No. - 138



LEO-023

Page No. - 138

HI-POWER LED OUTDOOR WALL LIGHT FIXTURES

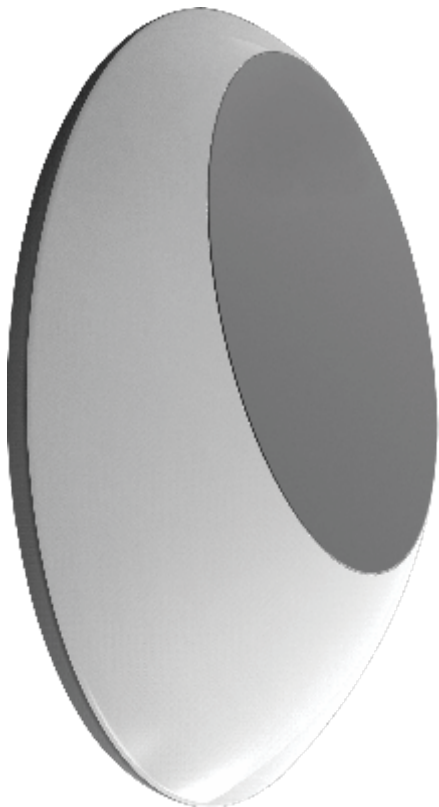

HI-POWER LED OUTDOOR WALL LIGHT FIXTURES

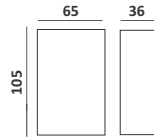

Description : Up Down Wall Light
 Material : Aluminium Die-Cast
 Finish : Graphite Black
 Power Watt. : 2W
 Input Voltage : 230v - 240v - 50Hz
 Light Source : 2 x 1W LED
 Lumens Flux : 110 LM
 CCT : 3000K
 Beam Angle : 53°
 IP Rating : IP54

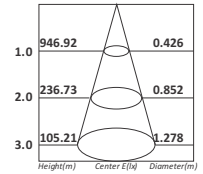

LLO-001

Powered by: **CREE** LEDs

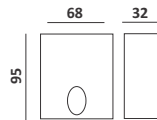

Description : Wall Light
 Material : Aluminium Die-Cast
 Finish : Graphite Black
 Power Watt. : 3W
 Input Voltage : 230v - 240v - 50Hz
 Light Source : 1 x 3W LED
 Lumens Flux : 114 LM
 CCT : 3000K
 Beam Angle : 31°
 IP Rating : IP54

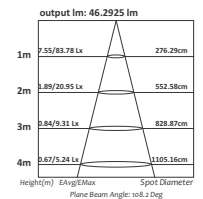

LLO-002

Powered by: **CREE** LEDs

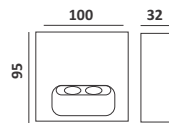

Description : Wall Light
 Material : Aluminium Die-Cast
 Finish : Graphite Black
 Power Watt. : 2W
 Input Voltage : 230v - 240v - 50Hz
 Light Source : 2 x 1W LED
 Lumens Flux : 101 LM
 CCT : 3000K
 Beam Angle : 36°
 IP Rating : IP54

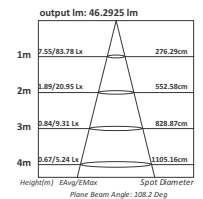

LLO-003

Powered by: **CREE** LEDs

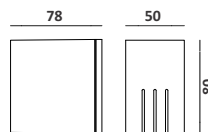

Description : Up or Down Wall Light
 Material : Aluminium Die-Cast
 Finish : Dark Grey
 Power Watt. : 3W
 Input Voltage : 230v - 240v - 50Hz
 Light Source : 1 x 3W COB
 Lumens Flux : 120 LM
 CCT : 3000K
 Beam Angle : 5°/81°
 IP Rating : IP54

LLO-005

Powered by: **CREE** LEDs

HI-POWER LED OUTDOOR WALL LIGHT FIXTURES

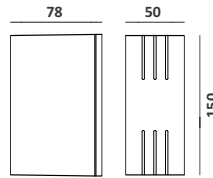

Description : Up Down Wall Light
 Material : Aluminium Die-Cast
 Finish : Dark Grey
 Power Watt. : 6W
 Input Voltage : 230v - 240v - 50Hz
 Light Source : 2 x 3W COB
 Lumens Flux : 236 LM
 CCT : 3000K
 Beam Angle : 5°/81°
 IP Rating : IP54

LLO-006

Powered by: **CREE** LEDs

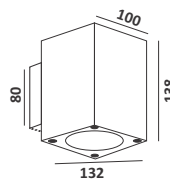

Description : Up or Down Wall Light
 Material : Aluminium Die-Cast
 Finish : Dark Grey
 Power Watt. : 12W
 Input Voltage : 230v - 240v - 50Hz
 Light Source : 1 x 12W COB
 Lumens Flux : 871 LM
 CCT : 3000K
 Beam Angle : 46°
 IP Rating : IP54

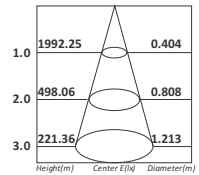

LLO-007

Powered by: **CREE** LEDs

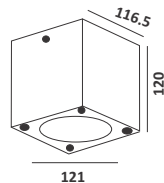

Description : Wall Light
 Material : Aluminium Die-Cast
 Finish : Dark Grey
 Power Watt. : 7W
 Input Voltage : 230v - 240v - 50Hz
 Light Source : 1 x 7W COB
 Lumens Flux : 504 LM
 CCT : 3000K
 Beam Angle : 18°
 IP Rating : IP54

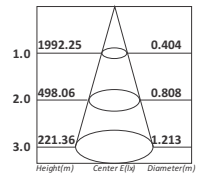

LLO-008

Powered by: **CREE** LEDs

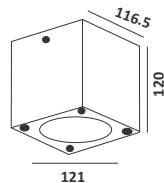

Description : Up Down Wall Light
 Material : Aluminium Die-Cast
 Finish : Dark Grey
 Power Watt. : 12W
 Input Voltage : 230v - 240v - 50Hz
 Light Source : 2 x 6W COB
 Lumens Flux : 827 LM
 CCT : 3000K
 Beam Angle : 18°
 IP Rating : IP54

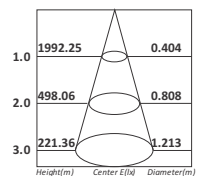

LLO-009

Powered by: **CREE** LEDs

HI-POWER LED OUTDOOR WALL LIGHT FIXTURES

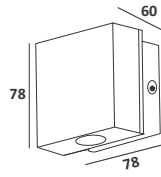

Description : Up Down Wall Light
 Material : Aluminium Die-Cast
 Finish : Graphite Black
 Power Watt. : 2W
 Input Voltage : 230v - 240v - 50Hz
 Light Source : 2 x 1W LED
 Lumens Flux : 182 LM
 CCT : 3000K
 Beam Angle : 44°
 IP Rating : IP54

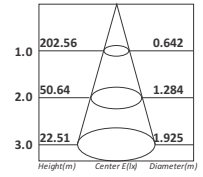

LLO-011

Powered by: **CREE** LEDs

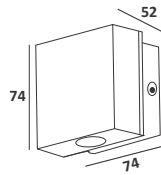

Description : Up or Down Wall Light
 Material : Aluminium Die-Cast
 Finish : Graphite Black
 Power Watt. : 1W
 Input Voltage : 230v - 240v - 50Hz
 Light Source : 1 x 1W LED
 Lumens Flux : 76 LM
 CCT : 3000K
 Beam Angle : 36°
 IP Rating : IP54

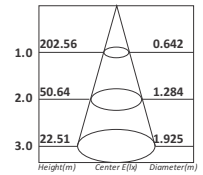

LLO-012

Powered by: **CREE** LEDs

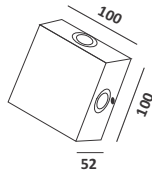

Description : 4-Way Wall Light - Square
 Material : Aluminium Die-Cast
 Finish : Graphite Black
 Power Watt. : 4W
 Input Voltage : 230v - 240v - 50Hz
 Light Source : 4 x 1W LED
 Lumens Flux : 321 LM
 CCT : 3000K
 Beam Angle : 11°
 IP Rating : IP54

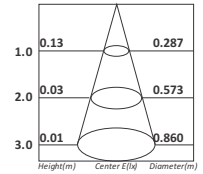

LLO-013

Powered by: **CREE** LEDs

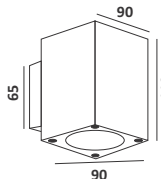

Description : Up Down Wall Light
 Material : Aluminium Die-Cast
 Finish : Graphite Black
 Power Watt. : 9W
 Input Voltage : 230v - 240v - 50Hz
 Light Source : 2 x 4.5W LED
 Lumens Flux : 285 LM
 CCT : 3000K
 Beam Angle : 22°/84°
 IP Rating : IP54

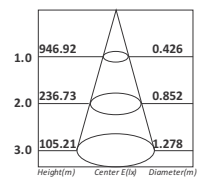

LLO-015

Powered by: **CREE** LEDs

HI-POWER LED OUTDOOR WALL LIGHT FIXTURES

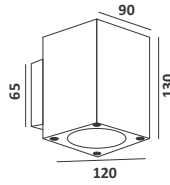

Description : Up Down Wall Light
 Material : Aluminium Die-Cast
 Finish : Graphite Black
 Power Watt. : 14W
 Input Voltage : 230v - 240v - 50Hz
 Light Source : 2 x 7W COB
 Lumens Flux : 839 LM
 CCT : 3000K
 Beam Angle : 21°
 IP Rating : IP54

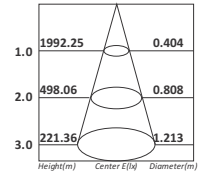

LLO-016

Powered by: **CREE** LEDs

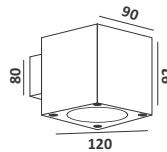

Description : Up or Down Wall Light
 Material : Aluminium Die-Cast
 Finish : Graphite Black
 Power Watt. : 7W
 Input Voltage : 230v - 240v - 50Hz
 Light Source : 1 x 7W COB
 Lumens Flux : 541 LM
 CCT : 3000K
 Beam Angle : 25°
 IP Rating : IP54

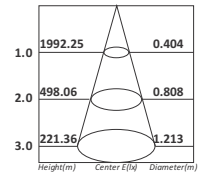

LLO-017

Powered by: **CREE** LEDs

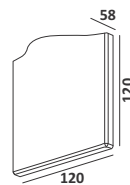
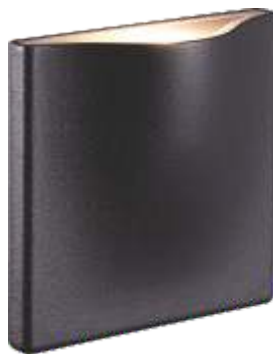

Description : Up or Down Wall Light
 Material : Aluminium Die-Cast
 Finish : Graphite Black
 Power Watt. : 7W
 Input Voltage : 230v - 240v - 50Hz
 Light Source : 1 x 7W COB
 Lumens Flux : 434 LM
 CCT : 3000k
 Beam Angle : 98°
 IP Rating : IP54

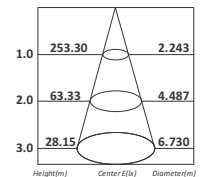

LLO-018

Powered by: **CREE** LEDs

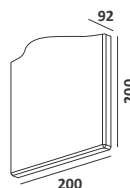

Description : Up or Down Wall Light
 Material : Aluminium Die-Cast
 Finish : Graphite Black
 Power Watt. : 15W
 Input Voltage : 230v - 240v - 50Hz
 Light Source : 1 x 15W COB
 Lumens Flux : 718 LM
 CCT : 3000K
 Beam Angle : 97°
 IP Rating : IP54

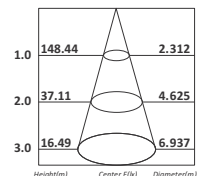

LLO-019

Powered by: **CREE** LEDs

HI-POWER LED OUTDOOR WALL LIGHT FIXTURES

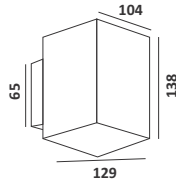

Description : Adjustable Up Down Wall Light
 Material : Aluminium Die-Cast
 Finish : Dark Grey
 Power Watt. : 12W
 Input Voltage : 230v - 240v - 50Hz
 Light Source : 2 x 6W CREE
 Lumens Flux : 750 LM
 CCT : 3000K
 Beam Angle : 80°
 IP Rating : IP54

LLO-019A

Powered by: **CREE** LEDs

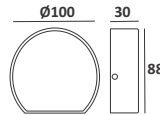

Description : Wall Light
 Material : Aluminium Die-Cast
 Finish : Graphite Black
 Power Watt. : 3W
 Input Voltage : 230v - 240v - 50Hz
 Light Source : 1 x 3W LED
 Lumens Flux : 121 LM
 CCT : 3000K
 Beam Angle : 99°
 IP Rating : IP54

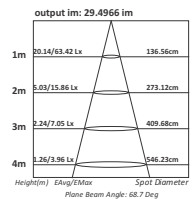

LLO-020

Powered by: **CREE** LEDs

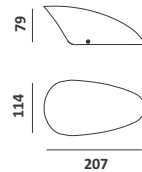

Description : Up or Down Wall Light
 Material : Aluminium Die-Cast
 Finish : Graphite Black
 Power Watt. : 12W
 Input Voltage : 230v - 240v - 50Hz
 Light Source : 1 x 12W COB
 Lumens Flux : 822 LM
 CCT : 3000k
 Beam Angle : 45°
 IP Rating : IP54

LLO-021

Powered by: **CREE** LEDs

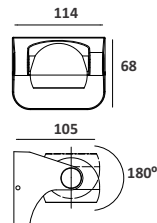

Description : Adjustable Wall Light
 Material : Aluminium Die-Cast
 Finish : Dark Grey
 Power Watt. : 6W
 Input Voltage : 230v - 240v - 50Hz
 Light Source : 2 x 3W COB
 Lumens Flux : 327 LM
 CCT : 3000K
 Beam Angle : 26°
 IP Rating : IP54

LLO-023

Powered by: **CREE** LEDs

HI-POWER LED OUTDOOR WALL LIGHT FIXTURES

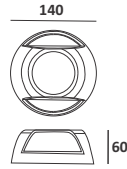

Description : Up Down Wall Light
 Material : Aluminium Die-Cast
 Finish : Dark Grey
 Power Watt. : 6W
 Input Voltage : 230v - 240v - 50Hz
 Light Source : 6 x 1W LED
 Lumens Flux : 540 LM
 CCT : 3000K
 Beam Angle : 10°/25°
 IP Rating : IP54

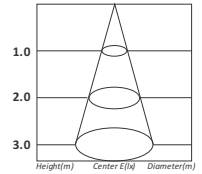

LLO-025

Powered by: **OSRAM**

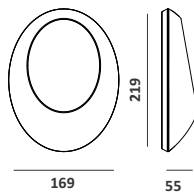

Description : Wall Light
 Material : Aluminium Die-Cast
 Finish : Dark Grey
 Power Watt. : 12W
 Input Voltage : 230v - 240v - 50Hz
 Light Source : SMD
 Lumens Flux : 1100 LM
 CCT : 3000K
 Beam Angle : -
 IP Rating : IP65

LLO-028

Powered by: **EPISTAR**

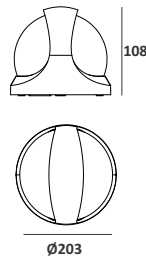

Description : Wall Light
 Material : Aluminium Die-Cast
 Finish : Dark Grey
 Power Watt. : 12W
 Input Voltage : 230v - 240v - 50Hz
 Light Source : SMD
 Lumens Flux : 1200 LM
 CCT : 3000K
 Beam Angle : -
 IP Rating : IP65

LLO-030

Powered by: **OSRAM**

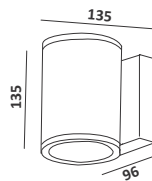

Description : Up Down Wall Light
 Material : Aluminium Die-Cast
 Finish : Graphite Black
 Power Watt. : 14W
 Input Voltage : 230v - 240v - 50Hz
 Light Source : 2 x 7W COB
 Lumens Flux : 719 LM
 CCT : 3000K
 Beam Angle : 23°
 IP Rating : IP54

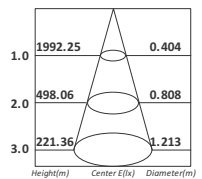

LLO-031

Powered by: **CREE LEDs**

HI-POWER LED OUTDOOR WALL LIGHT FIXTURES

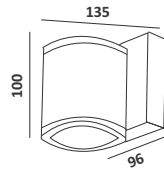

Description : Up Or Down Wall Light
 Material : Aluminium Die-Cast
 Finish : Graphite Black
 Power Watt. : 7W
 Input Voltage : 230v - 240v - 50Hz
 Light Source : 1 x 7W COB
 Lumens Flux : 719 LM
 CCT : 3000K
 Beam Angle : 23°
 IP Rating : IP54

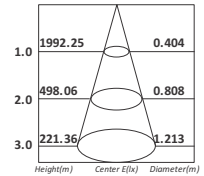

LLO-032

Powered by: **CREE** LEDs

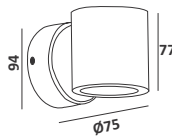

Description : Up or Down Wall Light
 Material : Aluminium Die-Cast
 Finish : Graphite Black
 Power Watt. : 3W
 Input Voltage : 230v - 240v - 50Hz
 Light Source : 1 x 3W LED
 Lumens Flux : 210 LM
 CCT : 3000K
 Beam Angle : 36°
 IP Rating : IP44

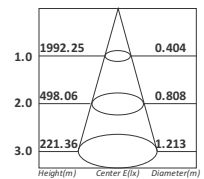

LLO-033

Powered by: **CREE** LEDs

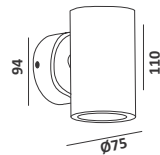

Description : Up Down Wall Light
 Material : Aluminium Die-Cast
 Finish : Graphite Black
 Power Watt. : 6W
 Input Voltage : 230v - 240v - 50Hz
 Light Source : 6 x 1W LED
 Lumens Flux : 392 LM
 CCT : 3000K
 Beam Angle : 44°
 IP Rating : IP54

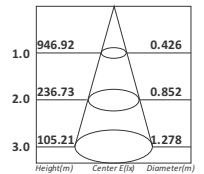

LLO-034

Powered by: **CREE** LEDs

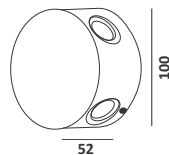

Description : 4-Way Wall Light - Round
 Material : Aluminium Die-Cast
 Finish : Graphite Black
 Power Watt. : 4W
 Input Voltage : 230v - 240v - 50Hz
 Light Source : 4 x 1W LED
 Lumens Flux : 321 LM
 CCT : 3000K
 Beam Angle : 11°
 IP Rating : IP54

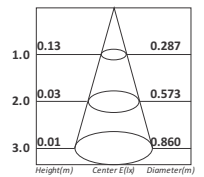

LLO-035

Powered by: **CREE** LEDs

HI-POWER LED OUTDOOR WALL LIGHT FIXTURES

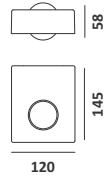

Description : Up or Down Wall Light
 Material : Aluminium Die-Cast
 Finish : Graphite Black
 Power Watt. : 3W
 Input Voltage : 230v - 240v - 50Hz
 Light Source : 1 x 3W COB
 Lumens Flux : 211 LM
 CCT : 3000K
 Beam Angle : 71°
 IP Rating : IP54

LLO-080

Powered by: **CREE** LEDs

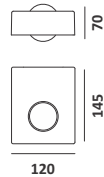

Description : Up Down Wall Light
 Material : Aluminium Die-Cast
 Finish : Graphite Black
 Power Watt. : 6W
 Input Voltage : 230v - 240v - 50Hz
 Light Source : 2 x 3W COB
 Lumens Flux : 345 LM
 CCT : 3000k
 Beam Angle : 71°
 IP Rating : IP54

LLO-081

Powered by: **CREE** LEDs

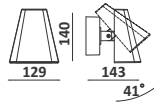

Description : Wall Light
 Material : Aluminium Die-Cast
 Finish : Graphite Black
 Power Watt. : 9W
 Input Voltage : 230v - 240v - 50Hz
 Light Source : 3 x 3W COB
 Lumens Flux : 615 LM
 CCT : 3000K
 Beam Angle : 22°
 IP Rating : IP54

LLO-082

Powered by: **CREE** LEDs

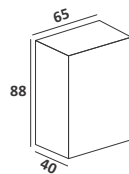

Description : Up or Down Wall Light
 Material : Aluminium Die-Cast
 Finish : Graphite Black
 Power Watt. : 3W
 Input Voltage : 230v - 240v - 50Hz
 Light Source : 1 x 3W LED
 Lumens Flux : 68 LM
 CCT : 3000K
 Beam Angle : 101°
 IP Rating : IP54

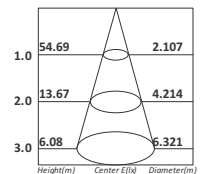

LLO-084

Powered by: **CREE** LEDs

HI-POWER LED OUTDOOR WALL LIGHT FIXTURES

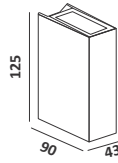

Description : Up | Down Wall Light
 Material : Aluminium Die-Cast
 Finish : Graphite Black
 Power Watt. : 9W
 Input Voltage : 230v - 240v - 50Hz
 Light Source : 2 x 4.5W COB
 Lumens Flux : 210 LM
 CCT : 3000k
 Beam Angle : 50°
 IP Rating : IP54

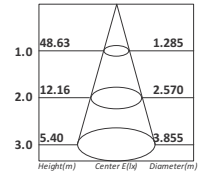

LLO-085

Powered by: **CREE** LEDs

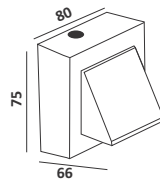

Description : Up or Down Wall Light
 Material : Aluminium Die-Cast
 Finish : Graphite Black
 Power Watt. : 1W
 Input Voltage : 230v - 240v - 50Hz
 Light Source : 1 x 1W LED
 Lumens Flux : 62 LM
 CCT : 3000K
 Beam Angle : 84°
 IP Rating : IP54

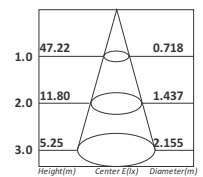

LLO-086

Powered by: **CREE** LEDs

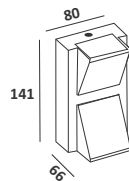

Description : Up Down Wall Light
 Material : Aluminium Die-Cast
 Finish : Graphite Black
 Power Watt. : 2W
 Input Voltage : 230v - 240v - 50Hz
 Light Source : 2 x 1W LED
 Lumens Flux : 128 LM
 CCT : 3000K
 Beam Angle : 87°
 IP Rating : IP54

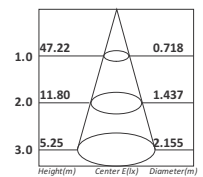

LLO-087

Powered by: **CREE** LEDs

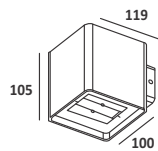

Description : Up Down Adjustable Wall Light
 Material : Aluminium Die-Cast
 Finish : Graphite Black
 Power Watt. : 10W
 Input Voltage : 230v - 240v - 50Hz
 Light Source : 2 x 5W LED
 Lumens Flux : 363 LM
 CCT : 3000K
 Beam Angle : 30° ~ 130°
 IP Rating : IP54

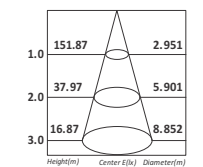

LLO-089

Powered by: **CREE** LEDs

HI-POWER LED OUTDOOR WALL LIGHT FIXTURES

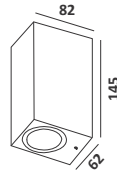

Description : Up Down Wall Light
 Material : Aluminium Die-Cast
 Finish : Graphite Black
 Power Watt. : 14W
 Input Voltage : 230v - 240v - 50Hz
 Light Source : 2 x 7W COB
 Lumens Flux : 928 LM
 CCT : 3000k
 Beam Angle : 73°
 IP Rating : IP54

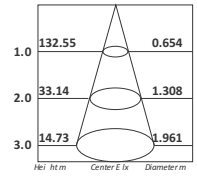

LLO-090

Powered by: **CREE** LEDs

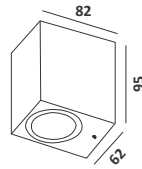

Description : Up or Down Wall Light
 Material : Aluminium Die-Cast
 Finish : Graphite Black
 Power Watt. : 7W
 Input Voltage : 230v - 240v - 50Hz
 Light Source : 1 x 7W LED
 Lumens Flux : 519 LM
 CCT : 3000K
 Beam Angle : 72°
 IP Rating : IP54

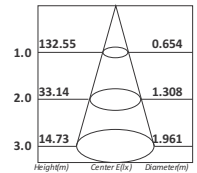

LLO-091

Powered by: **CREE** LEDs

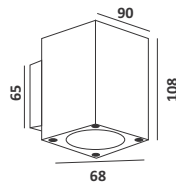

Description : Up Down Wall Light
 Material : Aluminium Die-Cast
 Finish : Graphite Black
 Power Watt. : 9W
 Input Voltage : 230v - 240v - 50Hz
 Light Source : 2 x 4.5W LED
 Lumens Flux : 373 LM
 CCT : 3000K
 Beam Angle : 44°
 IP Rating : IP65

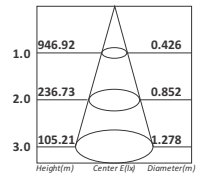

LLO-092

Powered by: **CREE** LEDs

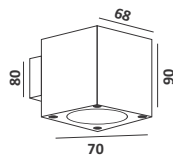

Description : Up or Down Wall Light
 Material : Aluminium Die-Cast
 Finish : Graphite Black
 Power Watt. : 4.5W
 Input Voltage : 230v - 240v - 50Hz
 Light Source : 1 x 4.5W LED
 Lumens Flux : 193 LM
 CCT : 3000K
 Beam Angle : 38°
 IP Rating : IP54

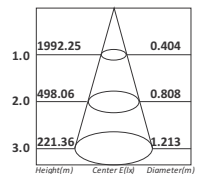

LLO-093

Powered by: **CREE** LEDs

HI-POWER LED OUTDOOR WALL LIGHT FIXTURES

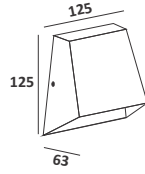

Description : Wall Light
 Material : Aluminium Die-Cast
 Finish : Graphite Black
 Power Watt. : 7W
 Input Voltage : 230v - 240v - 50Hz
 Light Source : 1 x 7W COB
 Lumens Flux : 344 LM
 CCT : 3000K
 Beam Angle : 108°
 IP Rating : IP54

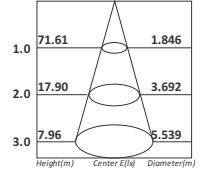

LLO-096

Powered by: **CREE** LEDs

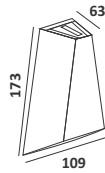

Description : Wall Light
 Material : Aluminium Die-Cast
 Finish : Graphite Black
 Power Watt. : 9W
 Input Voltage : 230v - 240v - 50Hz
 Light Source : 2 x 4.5W LED
 Lumens Flux : 105 LM
 CCT : 3000K
 Beam Angle : 15° / 78°
 IP Rating : IP54

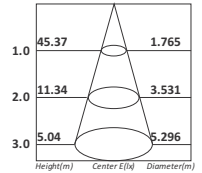

LLO-098

Powered by: **CREE** LEDs

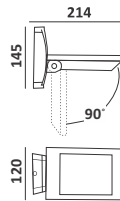

Description : Wall Light
 Material : Aluminium Die-Cast
 Finish : Graphite Black
 Power Watt. : 6W
 Input Voltage : 230v - 240v - 50Hz
 Light Source : 6 x 1W LED
 Lumens Flux : 650 LM
 CCT : 3000k
 Beam Angle : 24°
 IP Rating : IP54

LLO-099A

Powered by: **CREE** LEDs



LED OUTDOOR SURFACE FIXTURES



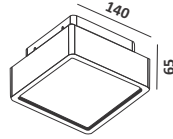

Description : Ceiling Light
 Material : Aluminium Die-Cast
 Finish : Graphite Black
 Power Watt. : 5W
 Input Voltage : 230v - 240v - 50Hz
 Light Source : 25 x 0.2W SMD
 Lumens Flux : 271 LM
 CCT : 3000K
 Beam Angle : 123°
 IP Rating : IP54

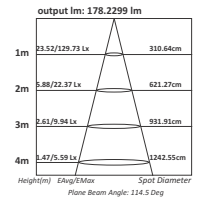

LLO-040

Powered by: **CREE** LEDs

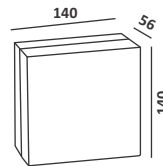

Description : Ceiling Light
 Material : Aluminium Die-Cast
 Finish : Dark Grey
 Power Watt. : 5W
 Input Voltage : 230v - 240v - 50Hz
 Light Source : 25 x 0.2W SMD
 Lumens Flux : 329 LM
 CCT : 3000K
 Beam Angle : 110°
 IP Rating : IP54

LLO-041

Powered by: **CREE** LEDs

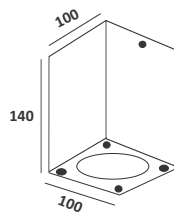

Description : Ceiling Light
 Material : Aluminium Die-Cast
 Finish : Dark Grey
 Power Watt. : 12W
 Input Voltage : 230v - 240v - 50Hz
 Light Source : 1 x 12W COB
 Lumens Flux : 871 LM
 CCT : 3000K
 Beam Angle : 46°
 IP Rating : IP54

LLO-042

Powered by: **CREE** LEDs

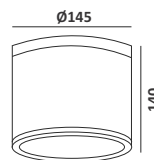

Description : Ceiling Light
 Material : Aluminium Die-Cast
 Finish : Dark Grey
 Power Watt. : 18W
 Input Voltage : 230v - 240v - 50Hz
 Light Source : 1 x 18W COB
 Lumens Flux : 1789 LM
 CCT : 3000K
 Beam Angle : 46°
 IP Rating : IP54

LLO-043

Powered by: **CREE** LEDs

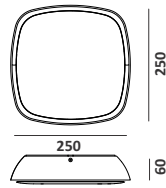

Description : Ceiling Light
 Material : Aluminium Die-Cast
 Finish : Dark Grey
 Power Watt. : 20W
 Input Voltage : 230v - 240v - 50Hz
 Light Source : SMD
 Lumens Flux : 1200 LM
 CCT : 3000K
 Beam Angle :-
 IP Rating : IP65

LLO-044

Powered by: **EPISTAR**

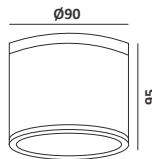

Description : Ceiling Light
 Material : Aluminium Die-Cast
 Finish : Graphite Black
 Power Watt. : 7W
 Input Voltage : 230v - 240v - 50Hz
 Light Source : 1 x 7W COB
 Lumens Flux : 480 LM
 CCT : 3000K
 Beam Angle : 17°
 IP Rating : IP54

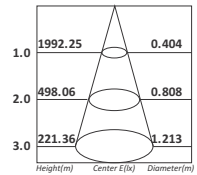

LLO-045

Powered by: **CREE LEDs**

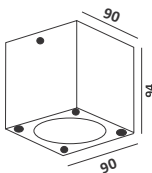

Description : Ceiling Light
 Material : Aluminium Die-Cast
 Finish : Graphite Black
 Power Watt. : 6W
 Input Voltage : 230v - 240v - 50Hz
 Light Source : 6 x 1W LED
 Lumens Flux : 385 LM
 CCT : 3000K
 Beam Angle : 23°
 IP Rating : IP54

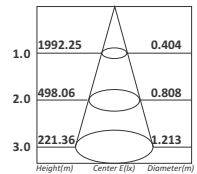

LLO-046

Powered by: **CREE LEDs**

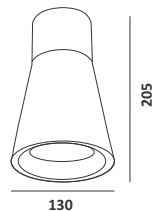

Description : Ceiling Light
 Material : Aluminium Die-Cast
 Finish : Graphite Black
 Power Watt. : 15W
 Input Voltage : 230v - 240v - 50Hz
 Light Source : 1 x 15W COB
 Lumens Flux : 854 LM
 CCT : 3000K
 Beam Angle : 55°
 IP Rating : IP54

LLO-047

Powered by: **CREE LEDs**

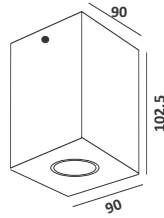

Description : Adjustable Ceiling Light
 Material : Aluminium Die-Cast
 Finish : Graphite Black
 Power Watt. : 9W
 Input Voltage : 230v - 240v - 50Hz
 Light Source : 1 x 9W COB
 Lumens Flux : 655 LM
 CCT : 3000K
 Beam Angle : 43°
 IP Rating : IP54

LLO-048

Powered by: **CREE** LEDs

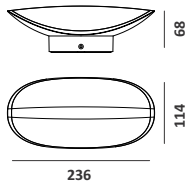

Description : Wall Light / Ceiling Light
 Material : Aluminium Die-Cast
 Finish : Dark Grey
 Power Watt. : 12W
 Input Voltage : 230v - 240v - 50Hz
 Light Source : SMD
 Lumens Flux : 1200 LM
 CCT : 3000K
 Beam Angle : -
 IP Rating : IP65

LLO-051

Powered by: **EPISTAR**



Description : Wall Light / Ceiling Light
 Material : Aluminium Die-Cast
 Finish : Dark Grey
 Power Watt. : 6W
 Input Voltage : 230v - 240v - 50Hz
 Light Source : 48 x 0.125W SMD
 Lumens Flux : 532 LM
 CCT : 3000K
 Beam Angle : 127°
 IP Rating : IP65

LLO-052

Powered by: **CREE** LEDs



SMD LED OUTDOOR WALL LIGHT FIXTURES



SMD LED OUTDOOR WALL LIGHT FIXTURES

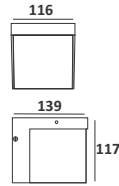

Description : Wall Light
Material : Aluminium Die-Cast
Finish : Graphite Black
Power Watt. : 5W
Input Voltage : 230v - 240v - 50Hz
Light Source : 25 x SMD
Lumens Flux : 253 LM
CCT : 3000K
Beam Angle : 114°
IP Rating : IP54

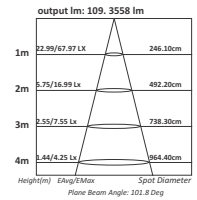

LLO-060

Powered by: **CREE** LEDs

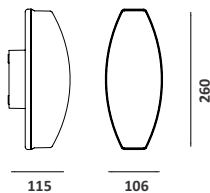

Description : Wall Light
Material : Aluminium Die-Cast
Finish : Dark Grey
Power Watt. : 6W
Input Voltage : 230v - 240v - 50Hz
Light Source : 42 x SMD
Lumens Flux : 453 LM
CCT : 3000K
Beam Angle : 144°
IP Rating : IP54

LLO-061

Powered by: **CREE** LEDs

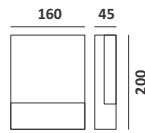

Description : Wall Light
Material : Aluminium Die-Cast
Finish : Graphite Black
Power Watt. : 6W
Input Voltage : 230v - 240v - 50Hz
Light Source : 42 x SMD
Lumens Flux : 460 LM
CCT : 3000K
Beam Angle : 121°
IP Rating : IP54

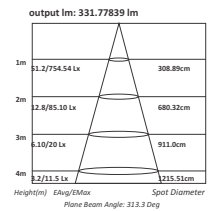

LLO-062

Powered by: **CREE** LEDs

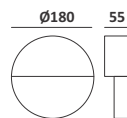

Description : Wall Light
Material : Aluminium Die-Cast
Finish : Graphite Black
Power Watt. : 6W
Input Voltage : 230v - 240v - 50Hz
Light Source : 18 x SMD
Lumens Flux : 322 LM
CCT : 3000K
Beam Angle : 149°
IP Rating : IP54

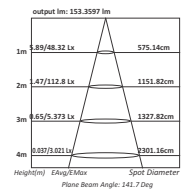

LLO-063

Powered by: **CREE** LEDs

SMD LED OUTDOOR WALL LIGHT FIXTURES

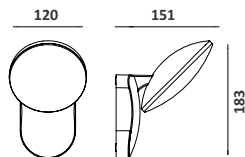

Description : Wall Light
 Material : Aluminium Die-Cast
 Finish : Graphite Black
 Power Watt. : 6W
 Input Voltage : 230v - 240v - 50Hz
 Light Source : 48 x SMD
 Lumens Flux : 384 LM
 CCT : 3000K
 Beam Angle : 110°
 IP Rating : IP54

LLO-068

Powered by: **CREE** LEDs

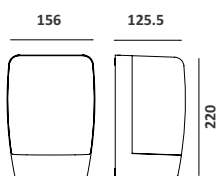

Description : Wall Light
 Material : Aluminium Die-Cast
 Finish : Graphite Black
 Power Watt. : 6W
 Input Voltage : 230v - 240v - 50Hz
 Light Source : 48 x SMD
 Lumens Flux : 384LM
 CCT : 3000K
 Beam Angle : 148°
 IP Rating : IP54

LLO-069

Powered by: **CREE** LEDs

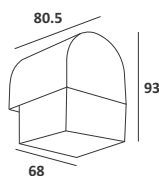

Description : Wall Light
 Material : Aluminium Die-Cast
 Finish : Graphite Black
 Power Watt. : 2W
 Input Voltage : 230v - 240v - 50Hz
 Light Source : 30 x SMD
 Lumens Flux : 125 LM
 CCT : 3000K
 Beam Angle : 128°
 IP Rating : IP54

LLO-071

Powered by: **CREE** LEDs



SMD LED OUTDOOR WALL LIGHT FIXTURES

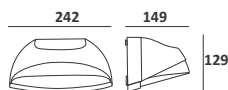

Description : Wall Light
Material : Aluminium Die-Cast
Finish : Graphite Black
Power Watt. : 12W
Input Voltage : 230v - 240v - 50Hz
Light Source : LED SMD
Lumens Flux : 1020LM
CCT : 3000K
Beam Angle :-
IP Rating : IP54

LLO-073

Powered by: **EPISTAR**

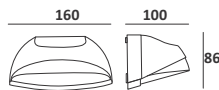

Description : Wall Light
Material : Aluminium Die-Cast
Finish : Graphite Black
Power Watt. : 6W
Input Voltage : 230v - 240v - 50Hz
Light Source : SMD
Lumens Flux : 540 LM
CCT : 3000K
Beam Angle :-
IP Rating : IP54

LLO-074

Powered by: **EPISTAR**



220V AC LED OUTDOOR WALL LIGHT FIXTURES



220V AC LED OUTDOOR WALL LIGHT FIXTURES

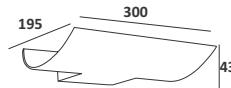

Description : Wall Light
 Material : Aluminium Die-Cast
 Finish : Graphite Black
 Power Watt. : 15W
 Input Voltage : 230v - 240v - 50Hz
 Light Source : SMD
 Lumens Flux : 1072 LM
 CCT : 3000K
 Beam Angle : 110°
 IP Rating : IP54

LLO-036

Powered by: **CREE** LEDs

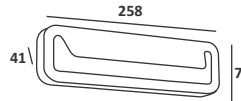

Description : Wall Light
 Material : Aluminium Die-Cast
 Finish : Graphite Black
 Power Watt. : 15W
 Input Voltage : 230v - 240v - 50Hz
 Light Source : SMD
 Lumens Flux : 360 LM
 CCT : 3000k
 Beam Angle : 74°
 IP Rating : IP65

LLO-094

Powered by: **CREE** LEDs

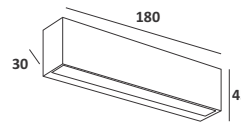

Description : Wall Light
 Material : Aluminium Die-Cast
 Finish : Graphite Black
 Power Watt. : 7W
 Input Voltage : 230v - 240v - 50Hz
 Light Source : SMD
 Lumens Flux : 208 LM
 CCT : 3000K
 Beam Angle : 90°
 IP Rating : IP65

LLO-095

Powered by: **CREE** LEDs

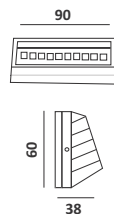

Description : Wall Light
 Material : Aluminium Die-Cast
 Finish : Graphite Black
 Power Watt. : 2W
 Input Voltage : 230v - 240v - 50Hz
 Light Source : 10 x SMD
 Lumens Flux : 116 LM
 CCT : 3000K
 Beam Angle : 98°
 IP Rating : IP65

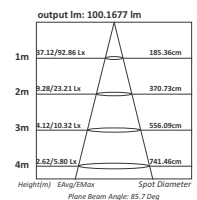

LLO-100

Powered by: **CREE** LEDs

220V AC LED OUTDOOR WALL LIGHT FIXTURES

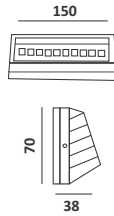
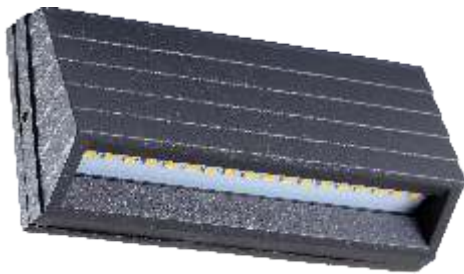

Description : Wall Light
 Material : Aluminium Die-Cast
 Finish : Graphite Black
 Power Watt. : 4W
 Input Voltage : 230v - 240v - 50Hz
 Light Source : 10 x SMD
 Lumens Flux : 235 LM
 CCT : 3000K
 Beam Angle : 98°
 IP Rating : IP65

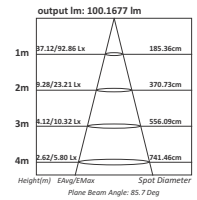

LLO-101

Powered by: **CREE** LEDs

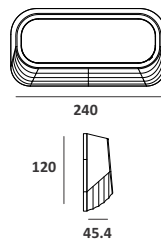

Description : Wall Light
 Material : Aluminium Die-Cast
 Finish : Graphite Black
 Power Watt. : 10W
 Input Voltage : 230v - 240v - 50Hz
 Light Source : 10 x SMD
 Lumens Flux : 1100 LM
 CCT : 3000K
 Beam Angle : -
 IP Rating : IP65

LLO-102

Powered by: **EPISTAR**

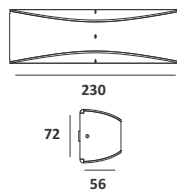
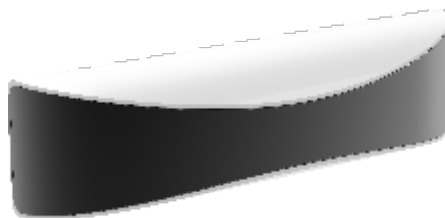

Description : Wall Light
 Material : Aluminium Die-Cast
 Finish : Graphite Black
 Power Watt. : 12W
 Input Voltage : 230v - 240v - 50Hz
 Light Source : SMD
 Lumens Flux : 1200 LM
 CCT : 3000K
 Beam Angle : -
 IP Rating : IP65

LLO-103

Powered by: **EPISTAR**

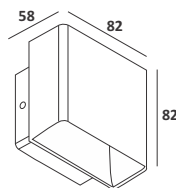

Description : Up Down Wall Light
 Material : Aluminium Die-Cast
 Finish : Graphite Black
 Power Watt. : 5W
 Input Voltage : 230v - 240v - 50Hz
 Light Source : 1 x 5W LED
 Lumens Flux : 158 LM
 CCT : 3000K
 Beam Angle : 96°
 IP Rating : IP 54

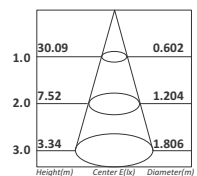

LLO-104

Powered by: **CREE** LEDs

220V AC LED OUTDOOR WALL LIGHT FIXTURES

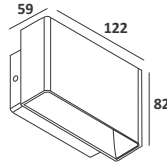
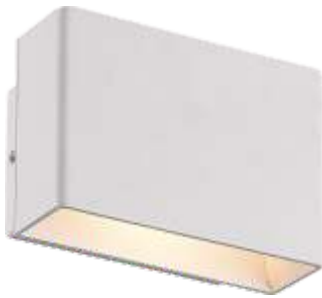

Description : Up Down Wall Light
 Material : Aluminium Die-Cast
 Finish : Graphite Black
 Power Watt. : 5W
 Input Voltage : 230v - 240v - 50Hz
 Light Source : 1 x 5W LED
 Lumens Flux : 173 LM
 CCT : 3000K
 Beam Angle : 107°
 IP Rating : IP54

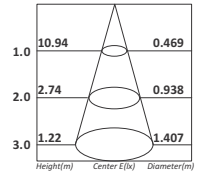

LLO-105

Powered by: **SAMSUNG**

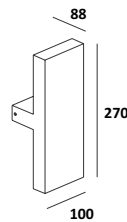

Description : Wall Light
 Material : Aluminium Die-Cast
 Finish : Graphite Black
 Power Watt. : 15W
 Input Voltage : 230v - 240v - 50Hz
 Light Source : SMD
 Lumens Flux : 893 LM
 CCT : 3000K
 Beam Angle : 131°
 IP Rating : IP54

LLO-106

Powered by: **CREE LEDs**

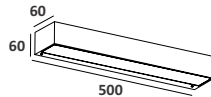

Description : UP Down Wall Washer
 Material : Aluminium Die-Cast
 Finish : Graphite Black
 Power Watt. : 35W
 Input Voltage : 230v - 240v - 50Hz
 Light Source : SMD
 Lumens Flux : 2232 LM
 CCT : 3000K
 Beam Angle : 107°
 IP Rating : IP65

LLO-107

Powered by: **CREE LEDs**

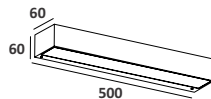

Description : Wall Washer
 Material : Aluminium Die-Cast
 Finish : Graphite Black
 Power Watt. : 18W
 Input Voltage : 230v - 240v - 50Hz
 Light Source : SMD
 Lumens Flux : 1188 LM
 CCT : 3000K
 Beam Angle : 107°
 IP Rating : IP65

LLO-108

Powered by: **CREE LEDs**

220V AC LED OUTDOOR WALL LIGHT FIXTURES

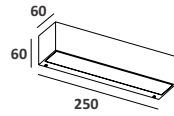

Description : Up Down Wall Washer
 Material : Aluminium Die-Cast
 Finish : Graphite Black
 Power Watt. : 18W
 Input Voltage : 230v - 240v - 50Hz
 Light Source : SMD
 Lumens Flux : 1086 LM
 CCT : 3000K
 Beam Angle : 110°
 IP Rating : IP65

LLO-109

Powered by: **CREE** LEDs

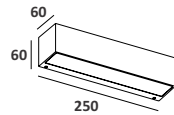

Description : Wall Washer
 Material : Aluminium Die-Cast
 Finish : Graphite Black
 Power Watt. : 9W
 Input Voltage : 230v - 240v - 50Hz
 Light Source : SMD
 Lumens Flux : 548 LM
 CCT : 3000K
 Beam Angle : 110°
 IP Rating : IP65

LLO-110

Powered by: **CREE** LEDs

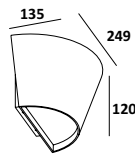

Description : Up Down Wall Light
 Material : Aluminium Die-Cast
 Finish : Graphite Black
 Power Watt. : 18W
 Input Voltage : 230v - 240v - 50Hz
 Light Source : SMD
 Lumens Flux : 864 LM
 CCT : 3000K
 Beam Angle : 55°
 IP Rating : IP54

LLO-111

Powered by: **CREE** LEDs

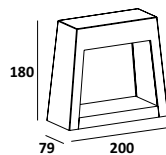

Description : Wall Light
 Material : Aluminium Die-Cast
 Finish : Graphite Black
 Power Watt. : 18W
 Input Voltage : 230v - 240v - 50Hz
 Light Source : SMD
 Lumens Flux : 570 LM
 CCT : 3000K
 Beam Angle : 28°
 IP Rating : IP65

LLO-112

Powered by: **CREE** LEDs

220V AC LED OUTDOOR WALL LIGHT FIXTURES

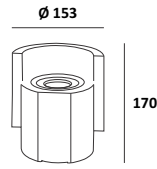

Description : Surface Wall Washer
Material : Aluminium Die-Cast
Finish : Graphite Black
Power Watt. : 15W
Input Voltage : 230v - 240v - 50Hz
Light Source : SMD
Lumens Flux : 1050 LM
CCT : 3000K
Beam Angle : 73°
IP Rating : IP65

LLO-113

Powered by: **CREE** LEDs



LED OUTDOOR WALL LIGHT FIXTURES - WHITE BODY



LED OUTDOOR WALL LIGHT FIXTURES - WHITE BODY

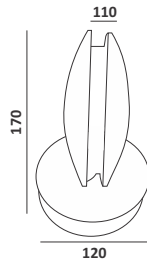

Description : Window Light
 Material : Aluminium Die-Cast
 Finish : Pearl White
 Power Watt. : 9W
 Input Voltage : 230v - 240v - 50Hz
 Light Source : 1 x 9W LED
 Lumens Flux : 612 LM
 CCT : 3000K
 Beam Angle : 17°
 IP Rating : IP65

LLO-130

Powered by: **OSRAM**

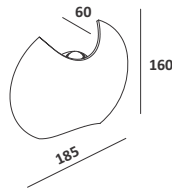

Description : Wall Light
 Material : Aluminium Die-Cast
 Finish : Pearl White
 Power Watt. : 6W
 Input Voltage : 230v - 240v - 50Hz
 Light Source : 2 x 3W COB
 Lumens Flux : 433 LM
 CCT : 3000K
 Beam Angle : 45°
 IP Rating : IP65

LLO-131

Powered by: **CREE** LEDs

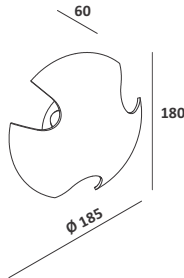

Description : Wall Light
 Material : Aluminium Die-Cast
 Finish : Pearl White
 Power Watt. : 9W
 Input Voltage : 230v - 240v - 50Hz
 Light Source : 3 x 3W COB
 Lumens Flux : 608 LM
 CCT : 3000K
 Beam Angle : 45°
 IP Rating : IP65

LLO-132

Powered by: **CREE** LEDs

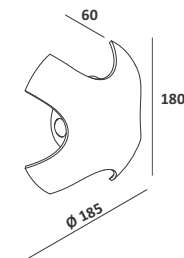

Description : Wall Light
 Material : Aluminium Die-Cast
 Finish : Pearl White
 Power Watt. : 12W
 Input Voltage : 230v - 240v - 50Hz
 Light Source : 4 x 3W COB
 Lumens Flux : 862 LM
 CCT : 3000K
 Beam Angle : 45°
 IP Rating : IP65

LLO-133

Powered by: **CREE** LEDs

LED OUTDOOR WALL LIGHT FIXTURES - WHITE BODY

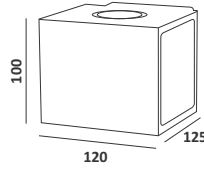

Description : Wall Light
 Material : Aluminium Die-Cast
 Finish : Pearl White
 Power Watt. : 10W
 Input Voltage : 230v - 240v - 50Hz
 Light Source : 2 x 5W LED
 Lumens Flux : 706 LM
 CCT : 3000K
 Beam Angle : 90°
 IP Rating : IP65

LLO-134

Powered by: **CREE** LEDs

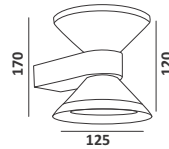

Description : Up Down Wall Light
 Material : Aluminium Die-Cast
 Finish : Pearl White
 Power Watt. : 10W
 Input Voltage : 230v - 240v - 50Hz
 Light Source : 2 x 5W LED
 Lumens Flux : 762 LM
 CCT : 3000K
 Beam Angle : 86°
 IP Rating : IP65

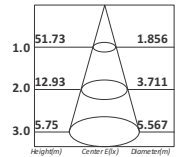

LLO-135

Powered by: **CREE** LEDs

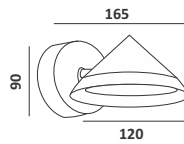

Description : Wall Light
 Material : Aluminium Die-Cast
 Finish : Pearl White
 Power Watt. : 5W
 Input Voltage : 230v - 240v - 50Hz
 Light Source : 5W LED
 Lumens Flux : 342 LM
 CCT : 3000K
 Beam Angle : 84°
 IP Rating : IP65

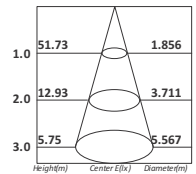

LLO-136

Powered by: **CREE** LEDs



Description : Up Down Wall Light
 Material : Aluminium Die-Cast
 Finish : Pearl White
 Power Watt. : 10W
 Input Voltage : 230v - 240v - 50Hz
 Light Source : 1 x 10W LED
 Lumens Flux : 712 LM
 CCT : 3000K
 Beam Angle : 31°
 IP Rating : IP65

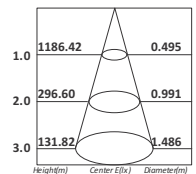

LLO-137

Powered by: **CREE** LEDs

LED OUTDOOR WALL LIGHT FIXTURES - WHITE BODY

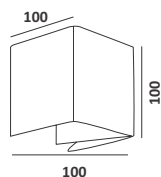

Description : Up & Down Adjustable Wall Light
 Material : Aluminium Die-Cast
 Finish : Pearl White
 Power Watt. : 2 x 4W
 Input Voltage : 230v - 240v - 50Hz
 Light Source : CREE LED
 Lumens Flux : 540 LM
 CCT : 3000K
 Beam Angle : 20°
 IP Rating : IP65

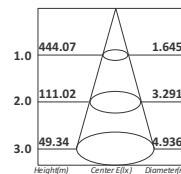

LLO-138

Powered by: **CREE** LEDs



LED INGROUND LIGHT FIXTURES

-(WITH IP68 CONNECTORS)



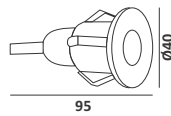

Description : Inground Light
 Material : Aluminium Die-Cast
 Finish : Stainless
 Power Watt. : 1W
 Input Voltage : 230v - 240v - 50Hz
 Light Source : 1 x 1W LED
 Lumens Flux : 45 LM
 CCT : 3000K
 Beam Angle : 24°
 IP Rating : IP65

LLO-120

Powered by: **CREE** LEDs

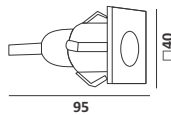

Description : Inground Light
 Material : Aluminium Die-Cast
 Finish : Stainless
 Power Watt. : 1W
 Input Voltage : 230v - 240v - 50Hz
 Light Source : 1 x 1W LED
 Lumens Flux : 45 LM
 CCT : 3000K
 Beam Angle : 24°
 IP Rating : IP65

LLO-121

Powered by: **CREE** LEDs

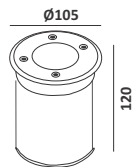

Description : Inground Light - Round
 Material : Aluminium Die-Cast
 Finish : Stainless
 Power Watt. : 3W
 Input Voltage : 230v - 240v - 50Hz
 Light Source : 1 x 3W COB
 Lumens Flux : 128 LM
 CCT : 3000K
 Beam Angle : 96°
 IP Rating : IP65

LLO-122

Powered by: **CREE** LEDs

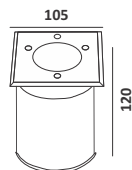

Description : Inground Light - Square
 Material : Aluminium Die-Cast
 Finish : Stainless
 Power Watt. : 3W
 Input Voltage : 230v - 240v - 50Hz
 Light Source : 1 x 3W COB
 Lumens Flux : 128 LM
 CCT : 3000K
 Beam Angle : 96°
 IP Rating : IP65

LLO-123

Powered by: **CREE** LEDs

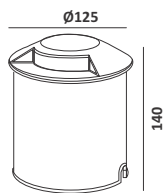

Description : 1-Way Inground Light Walk Over
 Material : Aluminium Die-Cast
 Finish : Graphite Black / Stainless Steel
 Power Watt. : 7W
 Input Voltage : 230v - 240v - 50Hz
 Light Source : 1 x 7W LED
 Lumens Flux : 67 LM
 CCT : 3000K
 Beam Angle : 110°
 IP Rating : IP67

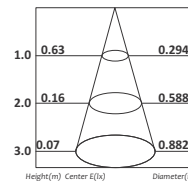

LLO-124

Powered by: **CREE** LEDs

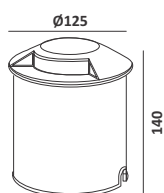

Description : 2-Way Inground Light Walk Over
 Material : Aluminium Die-Cast
 Finish : Graphite Black / Stainless Steel
 Power Watt. : 7W
 Input Voltage : 230v - 240v - 50Hz
 Light Source : 1 x 7W LED
 Lumens Flux : 135 LM
 CCT : 3000K
 Beam Angle : 99°
 IP Rating : IP67

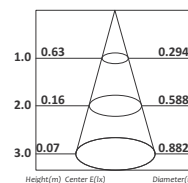

LLO-125

Powered by: **CREE** LEDs

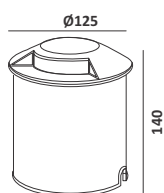

Description : 4-Way Inground Walk Over
 Material : Aluminium Die-Cast
 Finish : Graphite Black / Stainless Steel
 Power Watt. : 7W
 Input Voltage : 230v - 240v - 50Hz
 Light Source : 1 x 7W COB
 Lumens Flux : 188 LM
 CCT : 3000K
 Beam Angle : 70°
 IP Rating : IP67

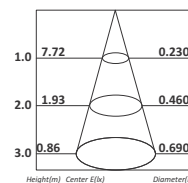

LLO-126

Powered by: **CREE** LEDs

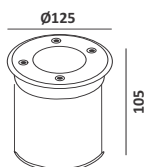

Description : Inground Light
 Material : Aluminium Die-Cast
 Finish : Graphite Black / Stainless Steel
 Power Watt. : 7W
 Input Voltage : 230v - 240v - 50Hz
 Light Source : 1 x 7W COB
 Lumens Flux : 473 LM
 CCT : 3000K
 Beam Angle : 24°
 IP Rating : IP67

LLO-127

Powered by: **CREE** LEDs

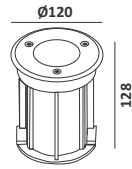

Description : Inground Light
 Material : Aluminium Die-Cast
 Finish : Graphite Black / Stainless Steel
 Power Watt. : 3W
 Input Voltage : 230v - 240v - 50Hz
 Light Source : 3 x 1W LED
 Lumens Flux : 175 LM
 CCT : 3000K
 Beam Angle : 26°
 IP Rating : IP67

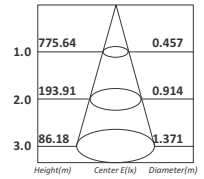

LLO-128

Powered by: **CREE** LEDs

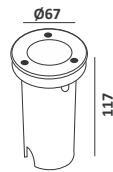

Description : Inground Light
 Material : Aluminium Die-Cast
 Finish : Graphite Black / Stainless Steel
 Power Watt. : 1W
 Input Voltage : 230v - 240v - 50Hz
 Light Source : 1 x 1W LED
 Lumens Flux : 68 LM
 CCT : 3000K
 Beam Angle : 28°
 IP Rating : IP67

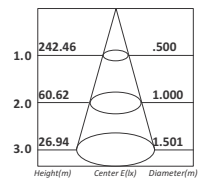

LLO-129

Powered by: **CREE** LEDs

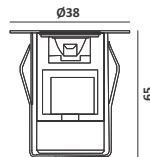

Description : Inground Wall Light - Round
 Material : Aluminium Die-Cast
 Finish : Graphite Black / Stainless Steel
 Power Watt. : 2W
 Input Voltage : 230v - 240v - 50Hz
 Light Source : 1 x 2W LED
 Lumens Flux : 160 LM
 CCT : 3000K
 Beam Angle : 30°
 IP Rating : IP67

LLO-129A

Powered by: **OSRAM**



LED OUTDOOR RECESSED LIGHT FIXTURES



LED OUTDOOR RECESSED LIGHT FIXTURES

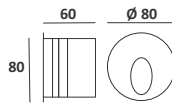

Description : Recessed Wall Light - Round
 Material : Aluminium Die-Cast
 Finish : Nickel Satin
 Power Watt. : 3W
 Input Voltage : 230v - 240v - 50Hz
 Light Source : 1 x 3W COB
 Lumens Flux : 108 LM
 CCT : 3000K
 Beam Angle : 78°
 IP Rating : IP54

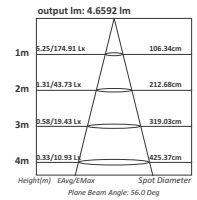

LLO-140

Powered by: **CREE** LEDs

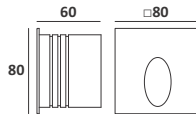

Description : Recessed Wall Light - Square
 Material : Aluminium Die-Cast
 Finish : Nickel Satin
 Power Watt. : 3W
 Input Voltage : 230v - 240v - 50Hz
 Light Source : 1 x 3W COB
 Lumens Flux : 108 LM
 CCT : 3000K
 Beam Angle : 78°
 IP Rating : IP54

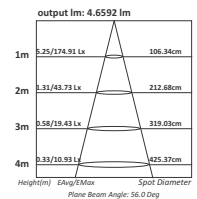

LLO-141

Powered by: **CREE** LEDs

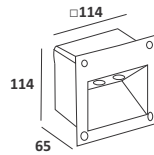

Description : Recessed Wall Light
 Material : Aluminium Die-Cast
 Finish : Graphite Black
 Power Watt. : 2W
 Input Voltage : 230v - 240v - 50Hz
 Light Source : 2 x 1W LED
 Lumens Flux : 169 LM
 CCT : 3000K
 Beam Angle : 29°
 IP : IP65

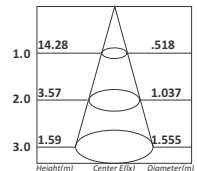

LLO-142

Powered by: **CREE** LEDs

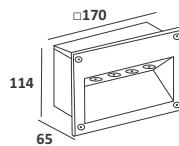

Description : Recessed Wall Light
 Material : Aluminium Die-Cast
 Finish : Graphite Black
 Power Watt. : 4W
 Input Voltage : 230v - 240v - 50Hz
 Light Source : 4 x 1W LED
 Lumens Flux : 327 LM
 CCT : 3000K
 Beam Angle : 31°
 IP Rating : IP65

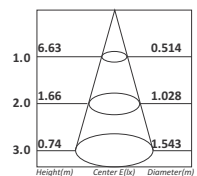

LLO-143

Powered by: **CREE** LEDs

LED OUTDOOR RECESSED LIGHT FIXTURES

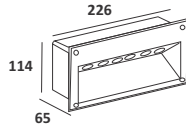
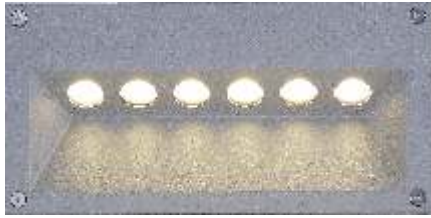

Description : Recessed Wall Light
 Material : Aluminium Die-Cast
 Finish : Graphite Black
 Power Watt. : 6W
 Input Voltage : 230v - 240v - 50Hz
 Light Source : 6 x 1W LED
 Lumens Flux : 529 LM
 CCT : 3000K
 Beam Angle : 29°
 IP Rating : IP65

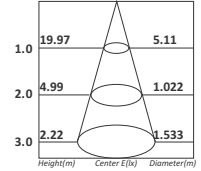

LLO-144

Powered by: **CREE** LEDs

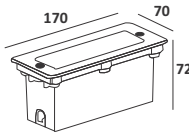

Description : Recessed Wall Light
 Material : Aluminium Die-Cast
 Finish : Stainless
 Power Watt. : 3W
 Input Voltage : 230v - 240v - 50Hz
 Light Source : 3 x 1W LED
 Lumens Flux : 89 LM
 CCT : 3000K
 Beam Angle : 84°
 IP Rating : IP65

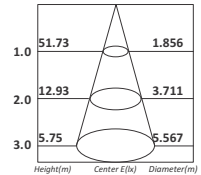

LLO-145

Powered by: **CREE** LEDs

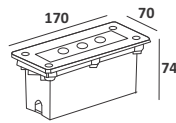

Description : Inground Light
 Material : Aluminium Die-Cast
 Finish : Stainless
 Power Watt. : 3W
 Input Voltage : 230v - 240v - 50Hz
 Light Source : 3 x 1W LED
 Lumens Flux : 198 LM
 CCT : 3000K
 Beam Angle : 31°
 IP Rating : IP67

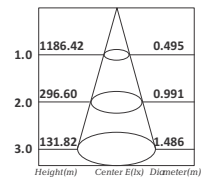

LLO-146

Powered by: **CREE** LEDs

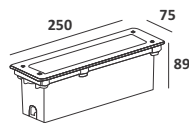

Description : Inground Light
 Material : Aluminium Die-Cast
 Finish : Stainless
 Power Watt. : 5W
 Input Voltage : 230v - 240v - 50Hz
 Light Source : 5 x 1W LED
 Lumens Flux : 310 LM
 CCT : 3000K
 Beam Angle : 31°
 IP Rating : IP67

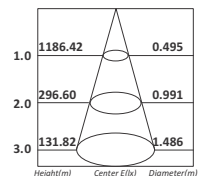

LLO-147

Powered by: **CREE** LEDs

LED OUTDOOR RECESSED LIGHT FIXTURES

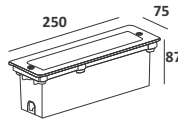

Description : Recessed Wall Light
 Material : Aluminium Die-Cast
 Finish : Stainless
 Power Watt. : 5W
 Input Voltage : 230v - 240v - 50Hz
 Light Source : 5 x 1W LED
 Lumens Flux : 157 LM
 CCT : 3000K
 Beam Angle : 86°
 IP Rating : IP65

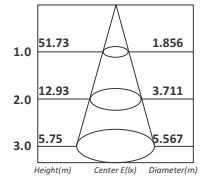

LLO-148

Powered by: **CREE** LEDs

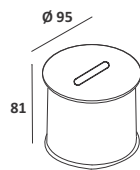

Description : Recessed Wall Light - Round
 Material : Aluminium Die-Cast
 Finish : Stainless
 Power Watt. : 3W
 Input Voltage : 230v - 240v - 50Hz
 Light Source : 1 x 3W LED
 Lumens Flux : 23 LM
 CCT : 3000K
 Beam Angle : 56°
 IP Rating : IP65

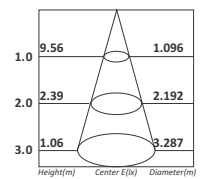

LLO-149

Powered by: **CREE** LEDs

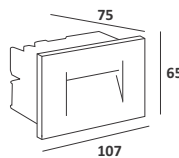

Description : Recessed Wall Light
 Material : Aluminium Die-Cast
 Finish : Graphite Black
 Power Watt. : 4W
 Input Voltage : 230v - 240v - 50Hz
 Light Source : SMD
 Lumens Flux : 75 LM
 CCT : 3000K
 Beam Angle : 33°
 IP Rating : IP65

LLO-150

Powered by: **CREE** LEDs

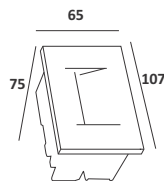

Description : Recessed Wall Light
 Material : Aluminium Die-Cast
 Finish : Graphite Black
 Power Watt. : 4W
 Input Voltage : 230v - 240v - 50Hz
 Light Source : SMD
 Lumens Flux : 99 LM
 CCT : 3000K
 Beam Angle : 48°
 IP Rating : IP65

LLO-151

Powered by: **CREE** LEDs

LED OUTDOOR RECESSED LIGHT FIXTURES

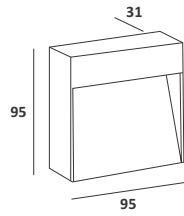

Description : Recessed Wall Light
 Material : Aluminium Die-Cast
 Finish : Graphite Black
 Power Watt. : 4W
 Input Voltage : 230v - 240v - 50Hz
 Light Source : SMD
 Lumens Flux : 145 LM
 CCT : 3000K
 Beam Angle : 33°
 IP Rating : IP65

LLO-152

Powered by: **CREE** LEDs

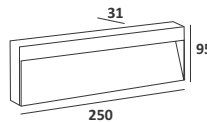

Description : Recessed Wall Light
 Material : Aluminium Die-Cast
 Finish : Graphite Black
 Power Watt. : 9W
 Input Voltage : 230v - 240v - 50Hz
 Light Source : SMD
 Lumens Flux : 390 LM
 CCT : 3000K
 Beam Angle : 33°
 IP Rating : IP65

LLO-153

Powered by: **CREE** LEDs

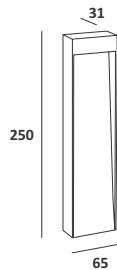

Description : Recessed Wall Light
 Material : Aluminium Die-Cast
 Finish : Graphite Black
 Power Watt. : 8W
 Input Voltage : 230v - 240v - 50Hz
 Light Source : SMD
 Lumens Flux : 250 LM
 CCT : 3000K
 Beam Angle : 48°
 IP Rating : IP65

LLO-154

Powered by: **CREE** LEDs

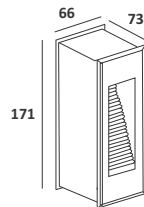

Description : Recessed Wall Light
 Material : Aluminium Die-Cast
 Finish : Graphite Black
 Power Watt. : 3W
 Input Voltage : 230v - 240v - 50Hz
 Light Source : 1 x 3W COB
 Lumens Flux : 59 LM
 CCT : 3000K
 Beam Angle : 20°
 IP Rating : IP65

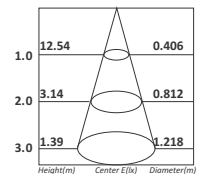

LLO-155

Powered by: **CREE** LEDs

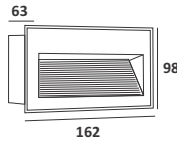

Description : Recessed Wall Light-Horizontal
 Material : Aluminium Die-Cast
 Finish : Graphite Black
 Power Watt. : 3W
 Input Voltage : 230v - 240v - 50Hz
 Light Source : 16 x SMD
 Lumens Flux : 360 LM
 CCT : 2700K
 Beam Angle :-
 IP Rating : IP65

LLO-156

Powered by: **EPISTAR**

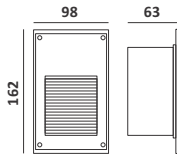

Description : Recessed Wall Light - Vertical
 Material : Aluminium Die-Cast
 Finish : Graphite Black
 Power Watt. : 3W
 Input Voltage : 230v - 240v - 50Hz
 Light Source : 16 x SMD
 Lumens Flux : 360 LM
 CCT : 2700K
 Beam Angle :-
 IP Rating : IP54

LLO-157

Powered by: **EPISTAR**



LED GARDEN LIGHT FIXTURES SPIKE/BASE

-(WITH IP68 CONNECTOR)





LED GARDEN LIGHT FIXTURES SPIKE/BASE -(WITH IP68 CONNECTOR)

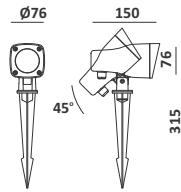

Description : Spot Light with Spike
Material : Aluminium Die-Cast
Finish : Graphite Black
Power Watt. : 7W
Input Voltage : 230v - 240v - 50Hz
Light Source : 1 x 7W COB
Lumens Flux : 472 LM
CCT : 3000K
Beam Angle : 74°
IP Rating : IP65

LLO-160

Powered by: **CREE** LEDs

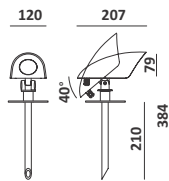

Description : Spot Light with Spike
Material : Aluminium Die-Cast
Finish : Graphite Black
Power Watt. : 12W
Input Voltage : 230v - 240v - 50Hz
Light Source : 1 x 12W COB
Lumens Flux : 822 LM
CCT : 3000K
Beam Angle : 45°
IP Rating : IP54

LLO-161

Powered by: **CREE** LEDs

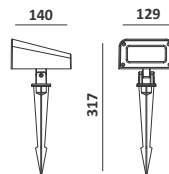

Description : Spot Light with Spike
Material : Aluminium Die-Cast
Finish : Graphite Black
Power Watt. : 9W
Input Voltage : 230v - 240v - 50Hz
Light Source : 3 x 3W COB
Lumens Flux : 615 LM
CCT : 3000K
Beam Angle : 22°
IP Rating : IP65

LLO-162

Powered by: **CREE** LEDs

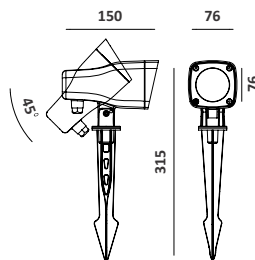

Description : Spot Light with Spike
Material : Aluminium Die-Cast
Finish : Graphite Black
Power Watt. : 12W
Input Voltage : 230v - 240v - 50Hz
Light Source : 1 x 12W COB
Lumens Flux : 810 LM
CCT : 3000K
Beam Angle : 25°
IP Rating : IP54

LLO-163

Powered by: **CREE** LEDs

LED GARDEN LIGHT FIXTURES SPIKE/BASE -(WITH IP68 CONNECTOR)

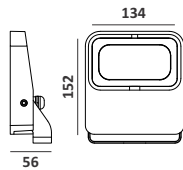

Description : Spot Light
Material : Aluminium Die-Cast
Finish : Graphite Black
Power Watt. : 8W
Input Voltage : 230v - 240v - 50Hz
Light Source : LEDs
Lumens Flux : 800 LM
CCT : 3000K
Beam Angle : 10°/ 25°
IP Rating : IP65

LLO-164

Powered by: **OSRAM**

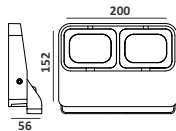

Description : Spot Light
Material : Aluminium Die-Cast
Finish : Graphite Black
Power Watt. : 12W
Input Voltage : 230v - 240v - 50Hz
Light Source : LEDs
Lumens Flux : 1200 LM
CCT : 3000K
Beam Angle : 10°/ 25°
IP Rating : IP65

LLO-165

Powered by: **OSRAM**

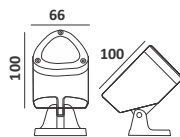

Description : Spot Light
Material : Aluminium Die-Cast
Finish : Graphite Black
Power Watt. : 3W
Input Voltage : 230v - 240v - 50Hz
Light Source : 1 x 3W COB
Lumens Flux : 240 LM
CCT : 3000K
Beam Angle : 25°
IP Rating : IP65

LLO-166

Powered by: **CREE** LEDs

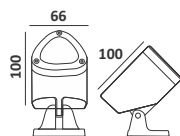

Description : Spot Light
Material : Aluminium Die-Cast
Finish : Graphite Black
Power Watt. : 3W
Input Voltage : 230v - 240v - 50Hz
Light Source : 3 x 1W COB
Lumens Flux : 270 LM
CCT : 3000K
Beam Angle : 25°
IP Rating : IP65

LLO-167

Powered by: **OSRAM**

LED GARDEN LIGHT FIXTURES SPIKE/BASE -(WITH IP68 CONNECTOR)

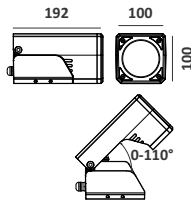

Description : Spot Light
Material : Aluminium Die-Cast
Finish : Graphite Black
Power Watt. : 6W
Input Voltage : 230v - 240v - 50Hz
Light Source : 6 x 1W LED
Lumens Flux : 540 LM
CCT : 3000K
Beam Angle : 10°/ 25°
IP Rating : IP65

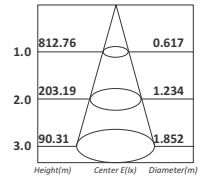

LLO-168

Powered by: **OSRAM**

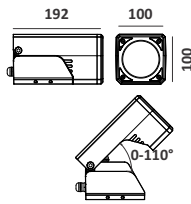

Description : Spot Light
Material : Aluminium Die-Cast
Finish : Graphite Black
Power Watt. : 12W
Input Voltage : 230v - 240v - 50Hz
Light Source : 1 x 12W COB
Lumens Flux : 1080 LM
CCT : 3000K
Beam Angle : 10°/ 25°
IP Rating : IP65

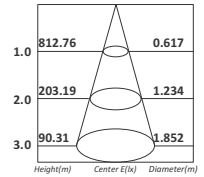

LLO-169

Powered by: **OSRAM**

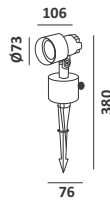

Description : Spot Light with Spike
Material : Aluminium Die-Cast
Finish : Graphite Black
Power Watt. : 7W
Input Voltage : 230v - 240v - 50Hz
Light Source : 1 x 7W COB
Lumens Flux : 372 LM
CCT : 3000K
Beam Angle : 37°
IP Rating : IP65

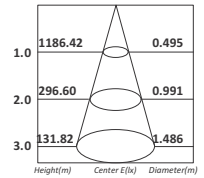

LLO-170

Powered by: **CREE LEDs**

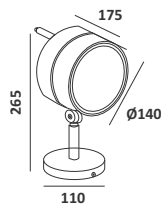

Description : Spot Light - Round
Material : Aluminium Die-Cast
Finish : Graphite Black
Power Watt. : 15W
Input Voltage : 230v - 240v - 50Hz
Light Source : 1 x 15W COB
Lumens Flux : 921 LM
CCT : 3000K
Beam Angle : 24°
IP Rating : IP65

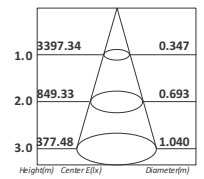

LLO-171

Powered by: **CREE LEDs**

LED GARDEN LIGHT FIXTURES SPIKE/BASE -(WITH IP68 CONNECTOR)

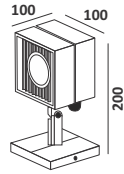

Description : Spot Light - Square
 Material : Aluminium Die-Cast
 Finish : Graphite Black
 Power Watt. : 12W
 Input Voltage : 230v - 240v - 50Hz
 Light Source : 1 x 12W COB
 Lumens Flux : 760 LM
 CCT : 3000K
 Beam Angle : 41°
 IP Rating : IP65

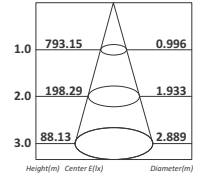

LLO-172

Powered by: **CREE** LEDs

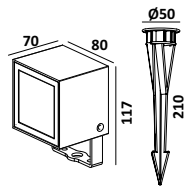

Description : Spot Light with Spike - Square
 Material : Aluminium Die-Cast
 Finish : Graphite Black
 Power Watt. : 8W
 Input Voltage : 230v - 240v - 50Hz
 Light Source : 4 x 2W LED
 Lumens Flux : 430 LM
 CCT : 3000K
 Beam Angle : 27°
 IP Rating : IP65

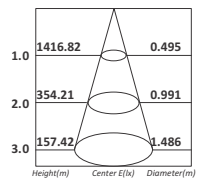

LLO-173

Powered by: **CREE** LEDs

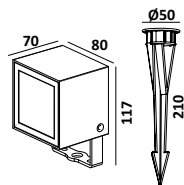

Description : Spot Light with Spike - Square
 Material : Aluminium Die-Cast
 Finish : Graphite Black
 Power Watt. : 7W
 Input Voltage : 230v - 240v - 50Hz
 Light Source : 1 x 7W COB
 Lumens Flux : 546 LM
 CCT : 3000K
 Beam Angle : 39°
 IP Rating : IP65

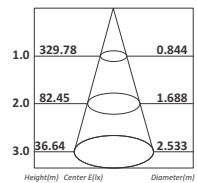

LLO-174

Powered by: **CREE** LEDs

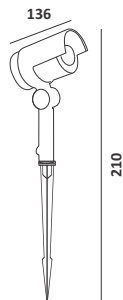

Description : Spot Light with spike
 Material : Aluminium Die-Cast
 Finish : Graphite Black
 Power Watt. : 15W
 Input Voltage : 230v - 240v - 50Hz
 Light Source : 1 x 15W COB
 Lumens Flux : 830 LM
 CCT : 3000K
 Beam Angle : 41°
 IP Rating : IP65

Powered by: **CREE** LEDs

LLO-175

LED SWIMMING POOL LIGHT (WITH IP68 CONNECTORS)



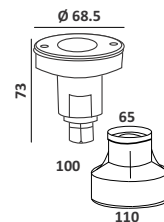

LSP-001 / 002 / 003 / 004

Powered by: **OSRAM** **EPISTAR**

Model No.	LSP-001	LSP-002	LSP-003	LSP-004
Description	Underwater Fountain Light	Underwater Fountain Light	Underwater Fountain Light	Underwater Fountain Light
Material	Aluminium Die-Cast	Aluminium Die-Cast	Aluminium Die-Cast	Aluminium Die-Cast
Finish	Stainless	Stainless	Stainless	Stainless
Power Watt.	2W	2W	2W	3W
Input Voltage	230v - 240v - 50Hz	230v - 240v - 50Hz	230v - 240v - 50Hz	230v - 240v - 50Hz
Light Source	1 x 2W LED	1 x 2W LED	1 x 2W LED	1 x 3W LED
Lumens Flux	160 LM	160 LM	160 LM	160 LM
CCT	3000K	Blue	Green	RGB 3 in 1
Beam Angle	30°	30°	30°	30°
IP Rating	IP68	IP68	IP68	IP68

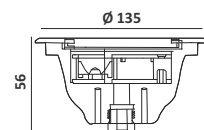

LSP-005/006/007/008

Powered by: **OSRAM** **EPISTAR**

Model No.	LSP-005	LSP-006	LSP-007	LSP-008
Description	Underwater Fountain Light	Underwater Fountain Light	Underwater Fountain Light	Underwater Fountain Light
Material	Aluminium Die-Cast	Aluminium Die-Cast	Aluminium Die-Cast	Aluminium Die-Cast
Finish	Stainless	Stainless	Stainless	Stainless
Power Watt.	8W	8W	8W	12W
Input Voltage	230v - 240v - 50Hz	230v - 240v - 50Hz	230v - 240v - 50Hz	230v - 240v - 50Hz
Light Source	4 x 2W LED	4 x 2W LED	4 x 2W LED	4 x 3W LED
Lumens Flux	640 LM	640 LM	640 LM	640 LM
CCT	3000K	Blue	Green	RGB 3 in 1
Beam Angle	30°	30°	30°	30°
IP Rating	IP68	IP68	IP68	IP68

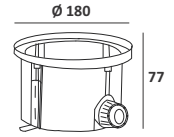

LSP-009 / 010 / 011 / 012

Powered by: **OSRAM** | **EPISTAR**

Model No.	LSP-009	LSP-010	LSP-011	LSP-012
Description	Underwater Fountain Light	Underwater Fountain Light	Underwater Fountain Light	Underwater Fountain Light
Material	Aluminium Die-Cast	Aluminium Die-Cast	Aluminium Die-Cast	Aluminium Die-Cast
Finish	Stainless	Stainless	Stainless	Stainless
Power Watt.	12W	12W	12W	18W
Input Voltage	230v - 240v - 50Hz	230v - 240v - 50Hz	230v - 240v - 50Hz	230v - 240v - 50Hz
Light Source	6 x 2W LED	6 x 2W LED	6 x 2W LED	6 x 3W LED
Lumens Flux	960 LM	960 LM	960 LM	960 LM
CCT	3000K	Blue	Green	RGB 3 in 1
Beam Angle	30°	30°	30°	30°
IP Rating	IP68	IP68	IP68	IP68

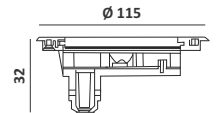

LSP - 013 / 014 / 015 / 016

Powered by: **OSRAM** | **EPISTAR**

Model No.	LSP-013	LSP-014	LSP-015	LSP-016
Description	Underwater Fountain Light Surface	Underwater Fountain Light Surface	Underwater Fountain Light Surface	Underwater Fountain Light Surface
Material	Aluminium Die-Cast	Aluminium Die-Cast	Aluminium Die-Cast	Aluminium Die-Cast
Finish	Stainless	Stainless	Stainless	Stainless
Power Watt.	12W	12W	12W	18W
Input Voltage	230v - 240v - 50Hz	230v - 240v - 50Hz	230v - 240v - 50Hz	230v - 240v - 50Hz
Light Source	6 x 2W LED	6 x 2W LED	6 x 2W LED	6 x 3W LED
Lumens Flux	960 LM	960 LM	960 LM	960 LM
CCT	3000K	Blue	Green	RGB 3 in 1
Beam Angle	30°	30°	30°	30°
IP Rating	IP68	IP68	IP68	IP68

LED SWIMMING POOL LIGHT (WITH IP68 CONNECTORS)

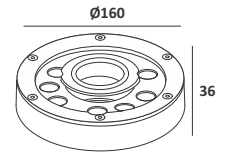

LSP-017 / 018 / 019 / 020

LSP-017 | LSP-018/019/020
Powered by: **OSRAM** | **EPISTAR**

Model No.	LSP-017	LSP-018	LSP-019	LSP-020
Description	Underwater Fountain Light	Underwater Fountain Light	Underwater Fountain Light	Underwater Fountain Light
Material	Aluminium Die-Cast	Aluminium Die-Cast	Aluminium Die-Cast	Aluminium Die-Cast
Finish	Stainless	Stainless	Stainless	Stainless
Power Watt.	18W	18W	18W	27W
Input Voltage	230v - 240v - 50Hz	230v - 240v - 50Hz	230v - 240v - 50Hz	230v - 240v - 50Hz
Light Source	9 x 2W LED	9 x 2W LED	9 x 2W LED	9 x 3W LED
Lumens Flux	960 LM	960 LM	960 LM	960 LM
CCT	3000K	Blue	Green	RGB 3 in 1
Beam Angle	30°	30°	30°	30°
IP Rating	IP68	IP68	IP68	IP68



LED SWIMMING POOL LIGHT (WITH IP68 CONNECTORS)



LSP-021 / 022

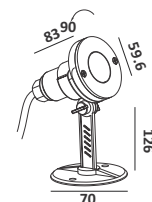

Model No.	LSP-021
Description	Underwater Fountain with base
Material	Aluminium Die-Cast
Finish	Stainless
Power Watt.	2W
Input Voltage	230v - 240v - 50Hz
Light Source	1 x 2W LED
Lumens Flux	160 LM
CCT	3000K
Beam Angle	30°
IP Rating	IP68

Model No.	LSP-022
Description	Underwater Fountain with base
Material	Aluminium Die-Cast
Finish	Stainless
Power Watt.	3W
Input Voltage	230v - 240v - 50Hz
Light Source	1 x 3W LED
Lumens Flux	240 LM
CCT	RGB 3 in 1
Beam Angle	30°
IP Rating	IP68

Powered by: **OSRAM**  **EPISTAR**



LSP-023 / 024

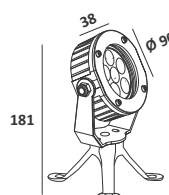

Model No.	LSP-023
Description	Underwater Fountain with base
Material	Aluminium Die-Cast
Finish	Stainless
Power Watt.	6W
Input Voltage	230v - 240v - 50Hz
Light Source	3 x 2W LED
Lumens Flux	480 LM
CCT	3000K
Beam Angle	30°
IP Rating	IP68

Model No.	LSP-024
Description	Underwater Fountain with base
Material	Aluminium Die-Cast
Finish	Stainless
Power Watt.	9W
Input Voltage	230v - 240v - 50Hz
Light Source	3 x 3W LED
Lumens Flux	720 LM
CCT	RGB 3 in 1
Beam Angle	30°
IP Rating	IP68

Powered by: **OSRAM**  **EPISTAR**



LSP-025 / 026

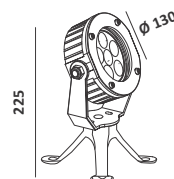

Model No.	LSP-025
Description	Underwater Fixture with base
Material	Aluminium Die-Cast
Finish	Stainless
Power Watt.	12W
Input Voltage	230v - 240v - 50Hz
Light Source	6 x 2W LED
Lumens Flux	960 LM
CCT	3000K
Beam Angle	30°
IP Rating	IP68

Model No.	LSP-026
Description	Underwater Fixture with base
Material	Aluminium Die-Cast
Finish	Stainless
Power Watt.	18W
Input Voltage	230v - 240v - 50Hz
Light Source	6 x 3W LED
Lumens Flux	1440 LM
CCT	RGB 3 in 1
Beam Angle	30°
IP Rating	IP68

LSP-025 | LSP-026
Powered by: **OSRAM**  **EPISTAR** 

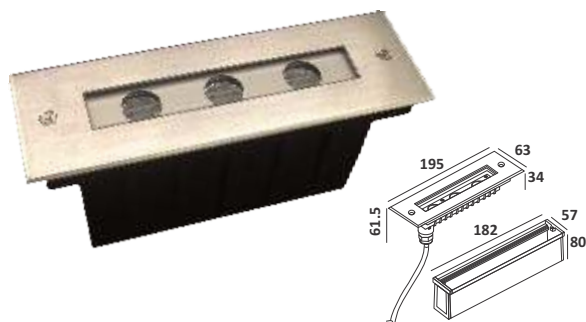

LSP-027

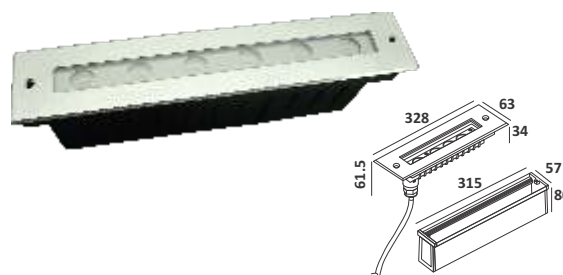

LSP-028

Model No.	LSP-027
Description	Concealed Underwater Fixture
Material	Aluminium Die-Cast
Finish	Stainless
Power Watt.	6W
Input Voltage	230v - 240v - 50Hz
Light Source	3 x 2W LED
Lumens Flux	480 LM
CCT	3000K
Beam Angle	30°
IP Rating	IP68

Model No.	LSP-028
Description	Concealed Underwater Fixture
Material	Aluminium Die-Cast
Finish	Stainless
Power Watt.	12W
Input Voltage	230v - 240v - 50Hz
Light Source	6 x 2W LED
Lumens Flux	720 LM
CCT	3000K
Beam Angle	30°
IP Rating	IP68

Powered by: **OSRAM** 

LED SURFACE WALL LIGHT & BOLLARDS





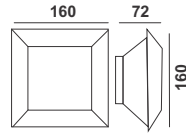

LLO-004

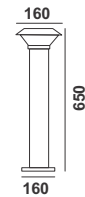

LB-031

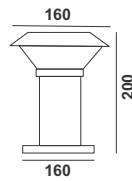

LB-030

Model No.	LLO-004	LB-030	LB-031
Material	Aluminium Die-Cast	Aluminium Die-Cast	Aluminium Die-Cast
Finish	Graphite Black	Graphite Black	Graphite Black
Power Watt.	8W	8W	8W
Input Voltage	230v - 240v - 50Hz	230v - 240v - 50Hz	230v - 240v - 50Hz
Light Source	8 x 1W	8 x 1W LED	8 x 1W
Lumens Flux	680 LM	487 LM	487 LM
CCT	3000K	3000K	3000K
Beam Angle	155°	155°	155°
IP Rating	IP54	IP54	IP54

- LLO-004** - Wall Light
- LB-030** - Bollard - Mini
- LB-031** - Bollard - Maxi

Powered by: **CREE** LEDs

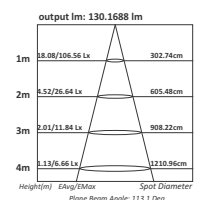

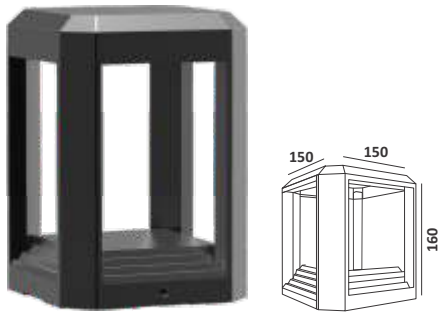

LLO-010

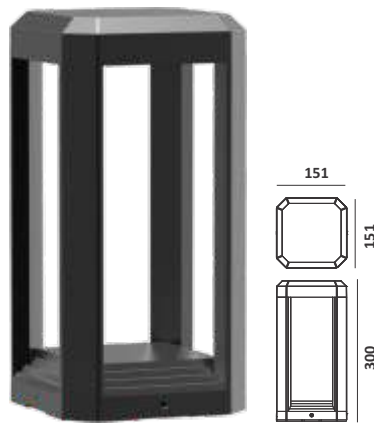

LB-100

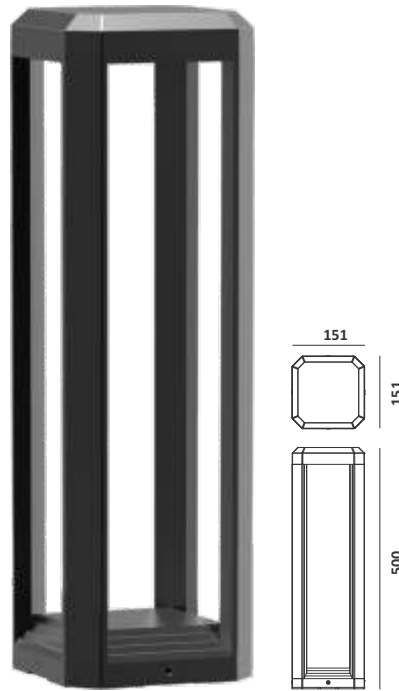

LB-101

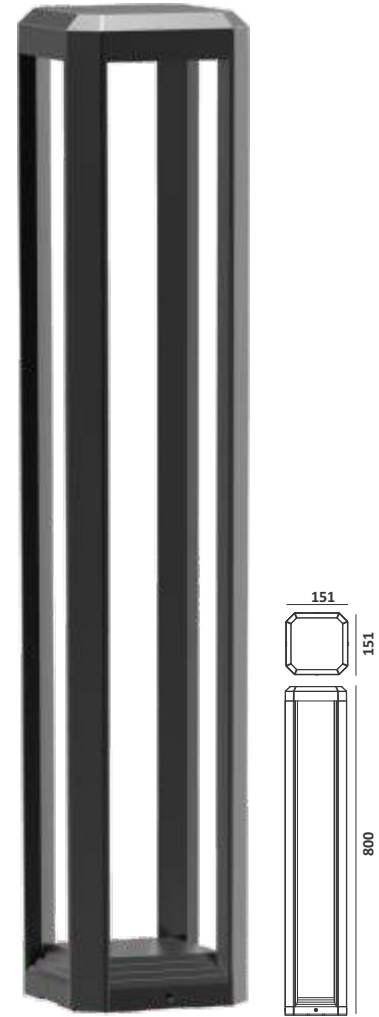

LB-102

Model No.	LLO-010	LB-100	LB-101	LB-102
Material	Aluminium Die-Cast	Aluminium Die-Cast	Aluminium Die-Cast	Aluminium Die-Cast
Finish	Graphite Black	Graphite Black	Graphite Black	Graphite Black
Power Watt.	12W	12W	12W	12W
Input Voltage	230v - 240v - 50Hz	230v - 240v - 50Hz	230v - 240v - 50Hz	230v - 240v - 50Hz
Light Source	10 x SMD	LED SMD	LED SMD	LED SMD
Lumens Flux	1400 LM	1400 LM	1400 LM	1400 LM
CCT	3000K	3000K	3000K	3000K
Beam Angle	-	-	-	-
IP Rating	IP54	IP54	IP54	IP54

- LLO-010** - Wall Light
- LB-100** - Lawn Light Bollard - Small
- LB-101** - Lawn Light Bollard - Medium
- LB-102** - Lawn Light Bollard - Large

Powered by: **OSRAM** 

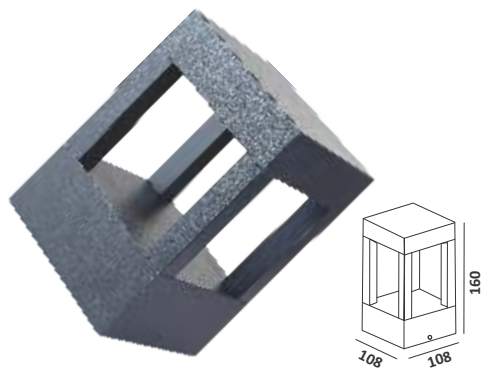

LLO-014



LB-058



LB-059

Model No.	LLO-014	LB-058	LB-059
Material	Aluminium Die-Cast	Aluminium Die-Cast	Aluminium Die-Cast
Finish	Graphite Black	Graphite Black	Graphite Black
Power Watt.	7W	7W	7W
Input Voltage	230v - 240v - 50Hz	230v - 240v - 50Hz	230v - 240v - 50Hz
Light Source	1 x 7W LED	1 x 7W LED	1 x 7W LED
Lumens Flux	368 LM	400 LM	442 LM
CCT	3000K	3000K	3000K
Beam Angle	84°	36°	44°
IP Rating	IP54	IP54	IP54

- LLO-014** - Wall Light
- LB-058** - Bollard - Mini
- LB-059** - Bollard - Maxi

Powered by: **CREE** LEDs

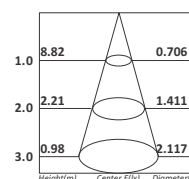

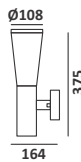

LLO-22



LB-035

Model No.	LLO-022	LB-035
Material	Aluminium Die-Cast	Aluminium Die-Cast
Finish	Graphite Black	Graphite Black
Power Watt.	9W	9W
Input Voltage	230v - 240v - 50Hz	230v - 240v - 50Hz
Light Source	3 x 3W COB	3 x 3W COB
Lumens Flux	318 LM	318 LM
CCT	3000K	3000K
Beam Angle	162°	162°
IP Rating	IP54	IP54

- LLO-022** - Wall Light
- LB-035** - Bollard - Maxi

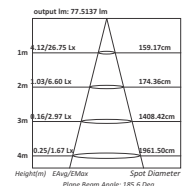

Powered by: **CREE** LEDs



LLO-24



LB-046

Model No.	LLO-024	LB-046
Material	Aluminium Die-Cast	Aluminium Die-Cast
Finish	Graphite Black	Graphite Black
Power Watt.	12W	12W
Input Voltage	230v - 240v - 50Hz	230v - 240v - 50Hz
Light Source	1 x 12W COB	1 x 12W COB
Lumens Flux	915 LM	915 LM
CCT	3000K	3000K
Beam Angle	40°	40°
IP Rating	IP54	IP54

LLO-024 - Wall Light

LB-046 - Bollard - Maxi

Powered by: **CREE** LEDs



LLO-026

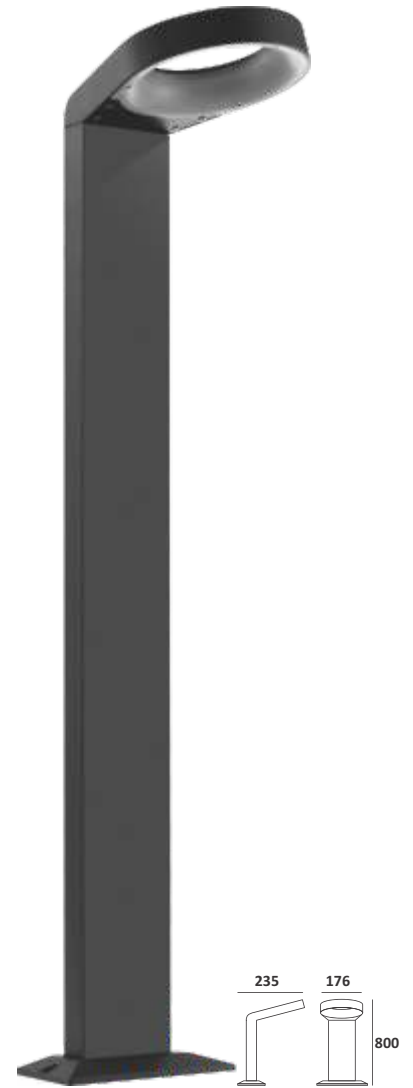

LB-082



LB-080



LB-081

Model No.	LLO-026	LB-080	LB-081	LB-082
Material	Aluminium Die-Cast	Aluminium Die-Cast	Aluminium Die-Cast	Aluminium Die-Cast
Finish	Graphite Black	Graphite Black	Graphite Black	Graphite Black
Power Watt.	6W	6W	6W	6W
Input Voltage	230v - 240v - 50Hz	230v - 240v - 50Hz	230v - 240v - 50Hz	230v - 240v - 50Hz
Light Source	LED SMD	SMD	SMD	SMD
Lumens Flux	480 LM	480 LM	480 LM	480 LM
CCT	3000K	3000K	3000K	3000K
Beam Angle	-	-	-	-
IP Rating	IP54	IP54	IP54	IP54

- LLO-026** - Wall Light
- LB-080** - Lawn Light Bollard - Small
- LB-081** - Lawn Light Bollard - Medium
- LB-082** - Lawn Light Bollard - Large

Powered by: **OSRAM**

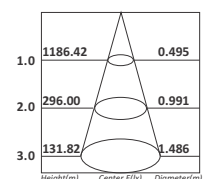

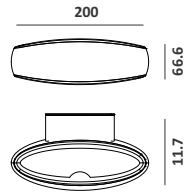

LLO-027

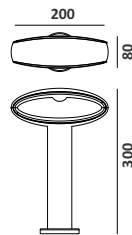

LB-050

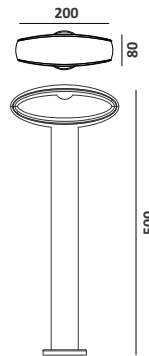
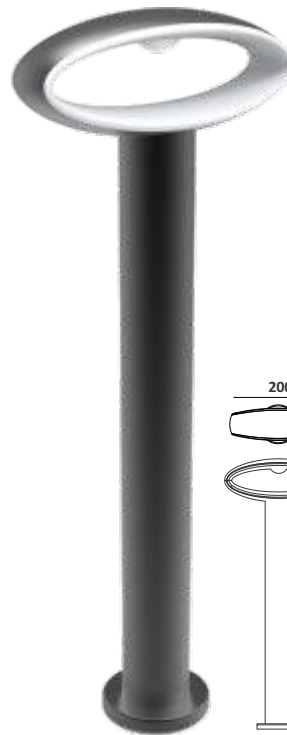

LB-051

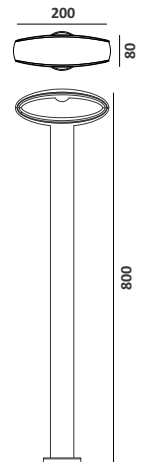

LB-052

Model No.	LLO-027	LB-050	LB-051	LB-052
Material	Aluminium Die-Cast	Aluminium Die-Cast	Aluminium Die-Cast	Aluminium Die-Cast
Finish	Graphite Black	Graphite Black	Graphite Black	Graphite Black
Power Watt.	9W	9W	9W	9W
Input Voltage	230v - 240v - 50Hz	230v - 240v - 50Hz	230v - 240v - 50Hz	230v - 240v - 50Hz
Light Source	LED SMD	LED SMD	LED SMD	LED SMD
Lumens Flux	810 LM	810 LM	810 LM	810 LM
CCT	3000K	3000K	3000K	3000K
Beam Angle	-	-	-	-
IP Rating	IP54	IP54	IP54	IP54

- LLO-027** - Wall Light
- LB-050** - Lawn Light Bollard - Small
- LB-051** - Lawn Light Bollard - Medium
- LB-052** - Lawn Light Bollard - Large

Powered by: **OSRAM** 



LLO-029

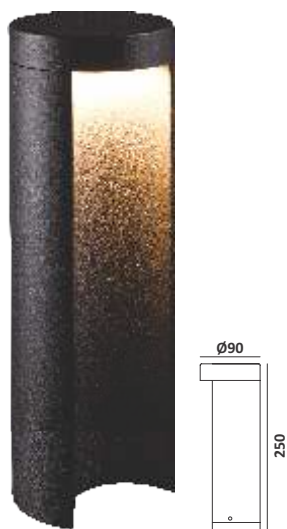

LB-032

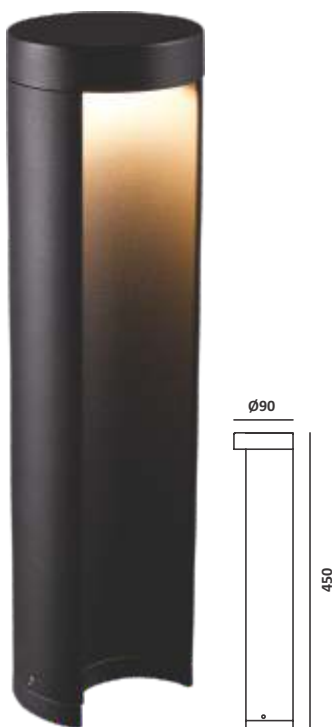

LB-033

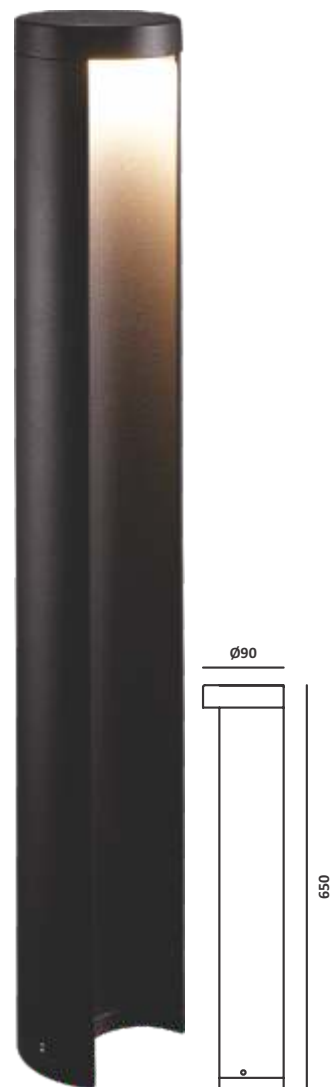

LB-034

Model No.	LLO-029	LB-032	LB-033	LB-034
Material	Aluminium Die-Cast	Aluminium Die-Cast	Aluminium Die-Cast	Aluminium Die-Cast
Finish	Graphite Black	Graphite Black	Graphite Black	Graphite Black
Power Watt.	7W	7W	7W	7W
Input Voltage	230v - 240v - 50Hz	230v - 240v - 50Hz	230v - 240v - 50Hz	230v - 240v - 50Hz
Light Source	1 x 7W COB	1 x 7W COB	1 x 7W COB	1 x 7W COB
Lumens Flux	427 LM	427 LM	427 LM	427 LM
CCT	3000K	3000K	3000K	3000K
Beam Angle	15°	15°	15°	15°
IP Rating	IP54	IP54	IP54	IP54

- LLO-029** - Up Or Down Wall Light
- LB-032** - Bollard - Mini
- LB-033** - Bollard - Medium
- LB-034** - Bollard - Maxi

Powered by: **CREE** LEDs



LLO-037



LB-087



LB-086

Model No.	LLO-037	LB-086	LB-087
Material	Aluminium Die-Cast	Aluminium Die-Cast	Aluminium Die-Cast
Finish	Graphite Black	Graphite Black	Graphite Black
Power Watt.	10W	10W	10W
Input Voltage	230v - 240v - 50Hz	230v - 240v - 50Hz	230v - 240v - 50Hz
Light Source	10 x 1W LED	10 x 1W LED	10 x 1W LED
Lumens Flux	364 LM	732 LM	900 LM
CCT	3000K	3000K	3000K
Beam Angle	360°	197°	53°
IP Rating	IP54	IP54	IP54

- LLO-097 - Wall Light
- LB-086 - Bollard - Mini
- LB-087 - Bollard - Maxi

Powered by: **CREE** LEDs

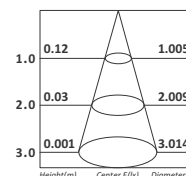

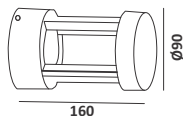

LLO-038

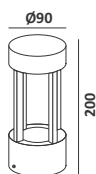

LB-083

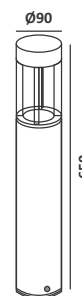

LB-084

Model No.	LLO-038	LB-083	LB-084
Material	Aluminium Die-Cast	Aluminium Die-Cast	Aluminium Die-Cast
Finish	Graphite Black	Graphite Black	Graphite Black
Power Watt.	7W	7W	7W
Input Voltage	230v - 240v - 50Hz	230v - 240v - 50Hz	230v - 240v - 50Hz
Light Source	1 x 7W COB	1 x 7W LED	1 x 7W COB
Lumens Flux	359 LM	397 LM	397 LM
CCT	3000K	3000K	3000K
Beam Angle	40°	41°	41°
IP Rating	IP54	IP54	IP54

- LLO-038** - Wall & Post Light
- LB-083** - Bollard - Mini
- LB-084** - Bollard - Large

Powered by: **CREE** LEDs

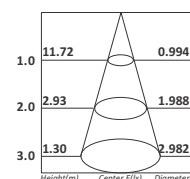



LLO-039



LB-085

Model No.	LLO-039	LB-085
Material	Aluminium Die-Cast	Aluminium Die-Cast
Finish	Graphite Black	Graphite Black
Power Watt.	6W	6W
Input Voltage	230v - 240v - 50Hz	230v - 240v - 50Hz
Light Source	1 x 6W COB	1 x 6W COB
Lumens Flux	456 LM	428 LM
CCT	3000K	3000K
Beam Angle	124°	142°
IP Rating	IP54	IP54

- LLO-039** - Wall Light
- LB-085** - Bollard - Maxi

Powered by: **CREE** LEDs

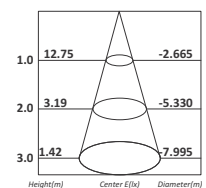

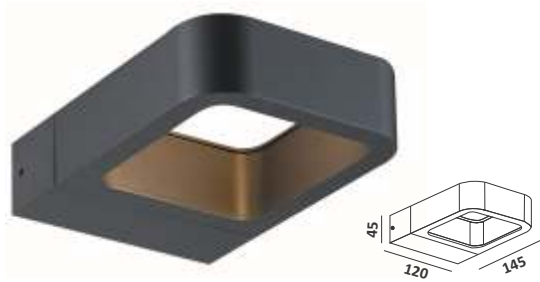

LLO-083



LB-038

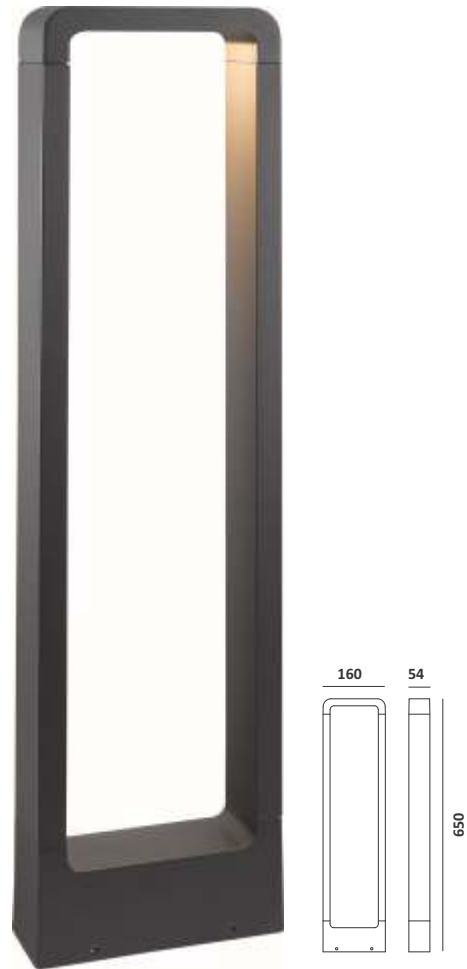

LB-039

Model No.	LLO-083	LB-038	LB-039
Material	Aluminium Die-Cast	Aluminium Die-Cast	Aluminium Die-Cast
Finish	Graphite Black	Graphite Black	Graphite Black
Power Watt.	7W	7W	7W
Input Voltage	230v - 240v - 50Hz	230v - 240v - 50Hz	230v - 240v - 50Hz
Light Source	1 x 7W COB	1 x 7W COB	1 x 7W COB
Lumens Flux	357 LM	375 LM	375 LM
CCT	3000K	3000K	3000K
Beam Angle	92°	92°	92°
IP Rating	IP54	IP54	IP54

LLO-083 - Wall Light

LB-038 - Bollard - Mini

LB-039 - Bollard - Large

Powered by: **CREE** LEDs

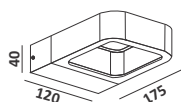
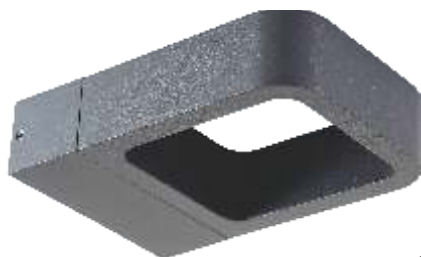

LLO-097

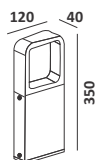

LB-056

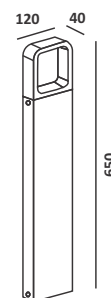

LB-057

Model No.	LLO-097	LB-056	LB-057
Material	Aluminium Die-Cast	Aluminium Die-Cast	Aluminium Die-Cast
Finish	Graphite Black	Graphite Black	Graphite Black
Power Watt.	7W	7W	7W
Input Voltage	230v - 240v - 50Hz	230v - 240v - 50Hz	230v - 240v - 50Hz
Light Source	1 x 7W COB	1 x 7W LED	1 x 7W LED
Lumens Flux	290 LM	290 LM	290 LM
CCT	3000K	3000K	3000K
Beam Angle	162°	45°	45°
IP Rating	IP54	IP54	IP54

- LLO-097** - Wall Light
- LB-056** - Bollard - Medium
- LB-057** - Bollard - Maxi

Powered by: **CREE** LEDs

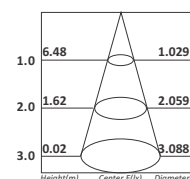

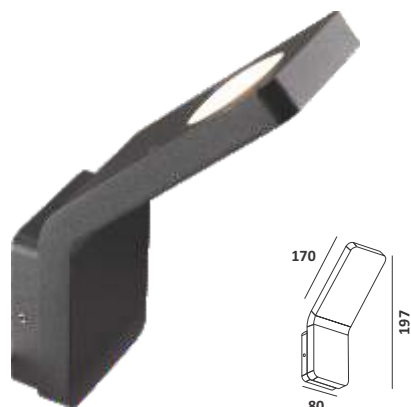

LLO-099



LLO-088



LB-053

Model No.	LLO-099	LLO-088	LB-053
Material	Aluminium Die-Cast	Aluminium Die-Cast	Aluminium Die-Cast
Finish	Graphite Black	Graphite Black	Graphite Black
Power Watt.	6W	6W	6W
Input Voltage	230v - 240v - 50Hz	230v - 240v - 50Hz	230v - 240v - 50Hz
Light Source	1 x 6W COB	1 x 6W COB	1 x 6W COB
Lumens Flux	367 LM	405 LM	367 LM
CCT	3000K	3000K	3000K
Beam Angle	106°	106°	103°
IP Rating	IP54	IP54	IP54

- LLO-099** - Wall Light
- LLO-088** - Wall Light
- LB-053** - Bollard - Large

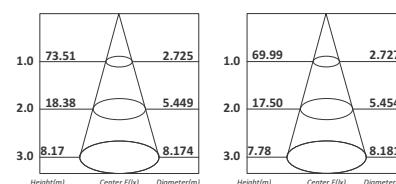

Powered by: **CREE** LEDs



LLO-064



LB-062

Model No.	LLO-064	LB-062
Material	Aluminium Die-Cast	Aluminium Die-Cast
Finish	Graphite Black	Graphite Black
Power Watt.	9W	9W
Input Voltage	230v - 240v - 50Hz	230v - 240v - 50Hz
Light Source	27 x SMD	27 x SMD
Lumens Flux	666 LM	666 LM
CCT	3000K	3000K
Beam Angle	103°	103°
IP Rating	IP54	IP54

- LLO-064** - Wall Light
- LB-062** - Bollard - Medium

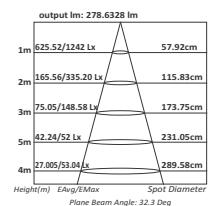

Powered by: **CREE** LEDs

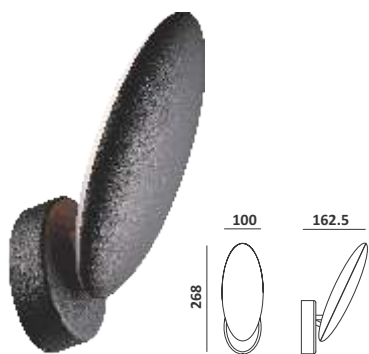

LLO-065



LB-060

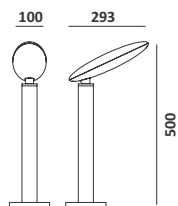

LB-061

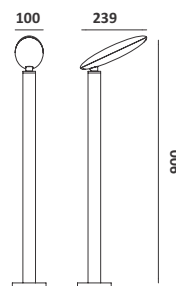

Model No.	LLO-065	LB-060	LB-061
Material	Aluminium Die-Cast	Aluminium Die-Cast	Aluminium Die-Cast
Finish	Graphite Black	Graphite Black	Graphite Black
Power Watt.	6W	6W	6W
Input Voltage	230v - 240v - 50Hz	230v - 240v - 50Hz	230v - 240v - 50Hz
Light Source	42 x SMD	42 x SMD	42 x SMD
Lumens Flux	545 LM	545 LM	545 LM
CCT	3000K	3000K	3000K
Beam Angle	108°	108°	108°
IP Rating	IP54	IP54	IP54

- LLO-065** - Wall Light
- LB-060** - Bollard - Medium
- LB-061** - Bollard - Maxi

Powered by: **CREE** LEDs

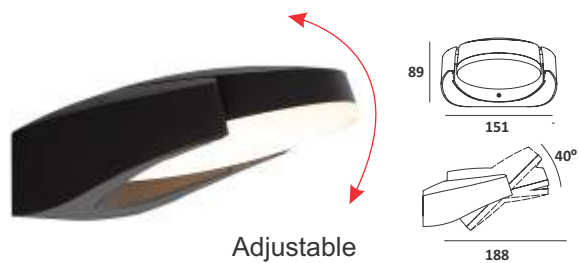

Adjustable

LLO-066

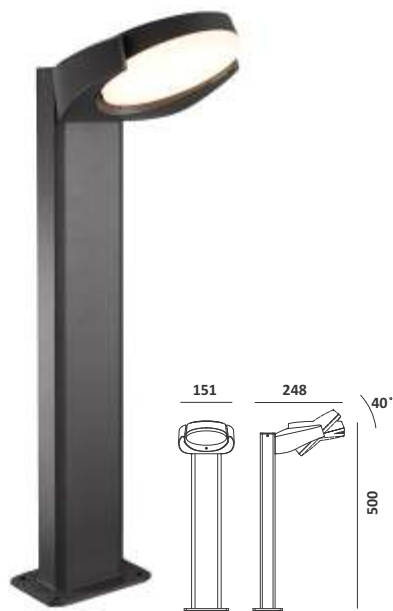

LB-065

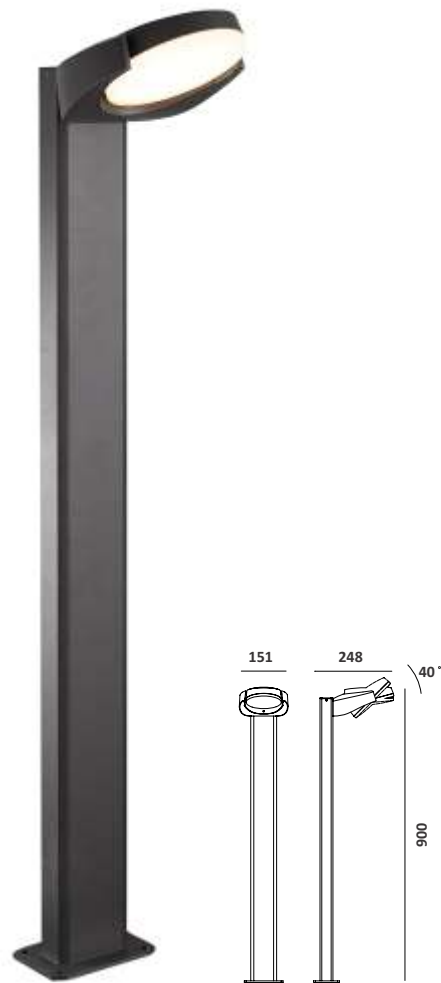

LB-066

Model No.	LLO-066	LB-065	LB-066
Material	Aluminium Die-Cast	Aluminium Die-Cast	Aluminium Die-Cast
Finish	Graphite Black	Graphite Black	Graphite Black
Power Watt.	6W	6W	6W
Input Voltage	230v - 240v - 50Hz	230v - 240v - 50Hz	230v - 240v - 50Hz
Light Source	48 x SMD	48 x SMD	48 x SMD
Lumens Flux	485 LM	485 LM	485 LM
CCT	3000K	3000K	3000K
Beam Angle	118°	118°	118°
IP Rating	IP54	IP54	IP54

- LLO-066** - Wall Light - Adjustable
- LB-065** - Bollard - Medium Adjustable
- LB-066** - Bollard - Maxi Adjustable

Powered by: **CREE** LEDs

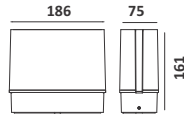

LLO-067

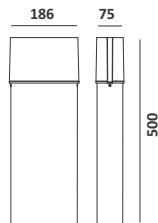

LB-067



LB-068

Model No.	LLO-067	LB-067	LB-068
Material	Aluminium Die-Cast	Aluminium Die-Cast	Aluminium Die-Cast
Finish	Graphite Black	Graphite Black	Graphite Black
Power Watt.	10W	10W	10W
Input Voltage	230v - 240v - 50Hz	230v - 240v - 50Hz	230v - 240v - 50Hz
Light Source	90 x SMD	90 x SMD	90 x SMD
Lumens Flux	632 LM	632 LM	632 LM
CCT	3000K	3000K	3000K
Beam Angle	360°	360°	360°
IP Rating	IP54	IP54	IP54

- LLO-067** - Wall Light
- LB-067** - Bollard - Medium
- LB-068** - Bollard - Maxi

Powered by: **CREE** LEDs



LLO-070



LB-072



LB-073

Model No.	LLO-070	LB-072	LB-073
Material	Aluminium Die-Cast	Aluminium Die-Cast	Aluminium Die-Cast
Finish	Graphite Black	Graphite Black	Graphite Black
Power Watt.	9W	9W	9W
Input Voltage	230v - 240v - 50Hz	230v - 240v - 50Hz	230v - 240v - 50Hz
Light Source	27 x SMD	27 x SMD	27 x SMD
Lumens Flux	400 LM	400 LM	400 LM
CCT	3000K	3000K	3000K
Beam Angle	154°	154°	154°
IP Rating	IP65	IP65	IP65

- LLO-070** - Wall Light
- LB-072** - Bollard - Medium
- LB-073** - Bollard - Maxi

Powered by: **CREE** LEDs

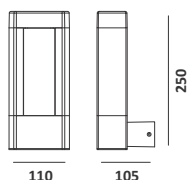

LLO-075

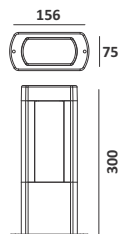

LB-077

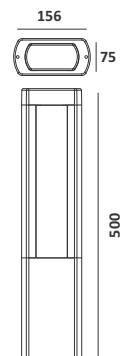

LB-078

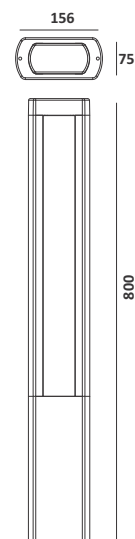

LB-079

Model No.	LLO-075	LB-077	LB-078	LB-079
Material	Aluminium Die-Cast	Aluminium Die-Cast	Aluminium Die-Cast	Aluminium Die-Cast
Finish	Graphite Black	Graphite Black	Graphite Black	Graphite Black
Power Watt.	10W	10W	12W	12W
Input Voltage	230v - 240v - 50Hz	230v - 240v - 50Hz	230v - 240v - 50Hz	230v - 240v - 50Hz
Light Source	LED SMD	LED SMD	LED SMD	LED SMD
Lumens Flux	900 LM	900 LM	1400 LM	1400 LM
CCT	3000K	3000K	3000K	3000K
Beam Angle	-	-	-	-
IP Rating	IP54	IP54	IP54	IP54

- LLO-075** - Wall Light
- LB-078** - Lawn Light Bollard - Small
- LB-079** - Lawn Light Bollard - Medium
- LB-080** - Lawn Light Bollard - Large

Powered by: **EPISTAR**

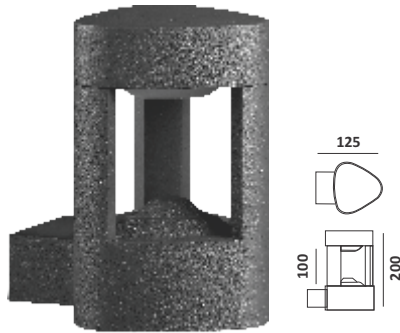

LLO-076

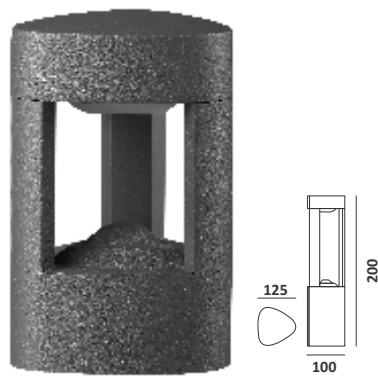

LB-074



LB-075



LB-076

Model No.	LLO-076	LB-074	LB-075	LB-076
Material	Aluminium Die-Cast	Aluminium Die-Cast	Aluminium Die-Cast	Aluminium Die-Cast
Finish	Graphite Black	Graphite Black	Graphite Black	Graphite Black
Power Watt.	9W	9W	9W	9W
Input Voltage	230v - 240v - 50Hz	230v - 240v - 50Hz	230v - 240v - 50Hz	230v - 240v - 50Hz
Light Source	SMD	SMD	SMD	SMD
Lumens Flux	820 LM	820 LM	820 LM	820 LM
CCT	3000K	3000K	3000K	3000K
Beam Angle	-	-	-	-
IP Rating	IP54	IP54	IP54	IP54

- LLO-076** - Wall Light
- LB-074** - Lawn Light Bollard - Small
- LB-075** - Lawn Light Bollard - Medium
- LB-076** - Lawn Light Bollard - Large

Powered by: **OSRAM**

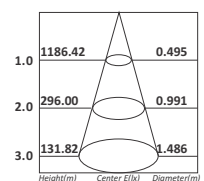

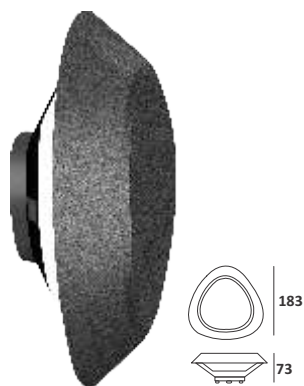

LLO-077



LB-047

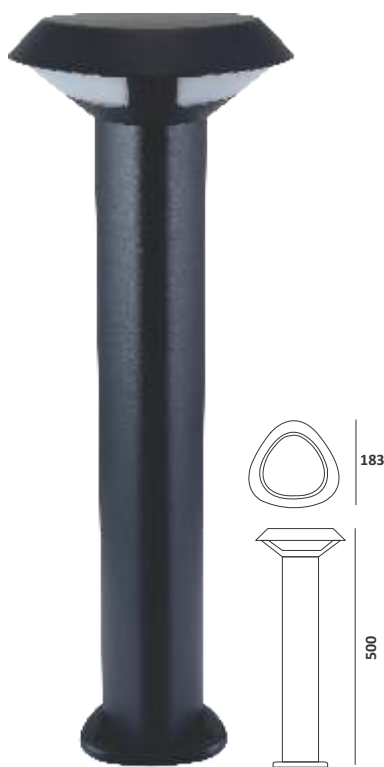

LB-048



LB-049

Model No.	LLO-077	LB-047	LB-048	LB-049
Material	Aluminium Die-Cast	Aluminium Die-Cast	Aluminium Die-Cast	Aluminium Die-Cast
Finish	Dark Grey	Dark Grey	Dark Grey	Dark Grey
Power Watt.	6W	6W	6W	6W
Input Voltage	230v - 240v - 50Hz	230v - 240v - 50Hz	230v - 240v - 50Hz	230v - 240v - 50Hz
Light Source	SMD	SMD	SMD	SMD
Lumens Flux	480 LM	480 LM	480 LM	480 LM
CCT	3000K	3000K	3000K	3000K
Beam Angle	-	-	-	-
IP Rating	IP54	IP54	IP54	IP54

- LLO-077** - Wall Light
- LB-047** - Lawn Light Bollard - Small
- LB-048** - Lawn Light Bollard - Medium
- LB-049** - Lawn Light Bollard - Large

Powered by: **OSRAM** 

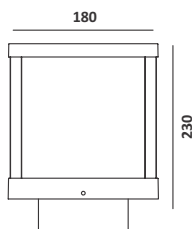

LB-036

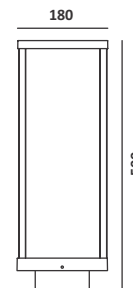

LB-037

Model No.	LB-036	LB-037
Material	Aluminium Die-Cast	Aluminium Die-Cast
Finish	Graphite Black	Graphite Black
Power Watt.	12W	12W
Input Voltage	230v - 240v - 50Hz	230v - 240v - 50Hz
Light Source	1 x 12W COB	1 x 12W COB
Lumens Flux	653 LM	653 LM
CCT	3000K	3000K
Beam Angle	124°	124°
IP Rating	IP54	IP54

LB-036 - Post Top

LB-037 - Bollard

Powered by: **CREE** LEDs

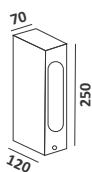

LB-040

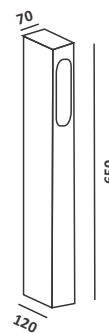

LB-041

Model No.	LB-040	LB-041
Material	Aluminium Die-Cast	Aluminium Die-Cast
Finish	Graphite Black	Graphite Black
Power Watt.	7W	7W
Input Voltage	230v - 240v - 50Hz	230v - 240v - 50Hz
Light Source	1 x 7W COB	1 x 7W COB
Lumens Flux	139 LM	139 LM
CCT	3000K	3000K
Beam Angle	36°	36°
IP Rating	IP54	IP54

LB-040 - Bollard - Small

LB-041 - Bollard - Large

Powered by: **CREE** LEDs

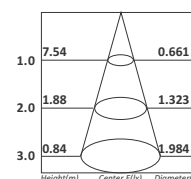

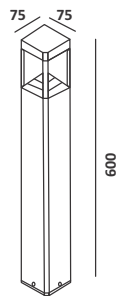

LB-042

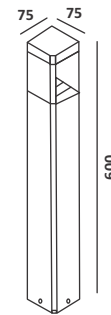

LB-054

Model No.	LB-042	LB-054
Material	Aluminium Die-Cast	Aluminium Die-Cast
Finish	Graphite Black	Graphite Black
Power Watt.	7W	7W
Input Voltage	230v - 240v - 50Hz	230v - 240v - 50Hz
Light Source	1 x 7W COB	1 x 7W COB
Lumens Flux	412 LM	258 LM
CCT	3000K	3000K
Beam Angle	42°	41°
IP Rating	IP54	IP54

- LB-042** - Bollard - Large AC LED
- LB-054** - Bollard - Large

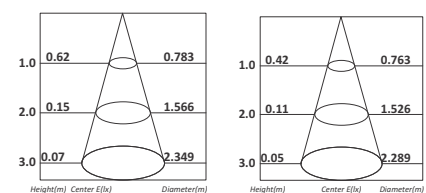

Powered by: **CREE** LEDs



LB-043

LB-044

LB-045

Model No.	LB-043	LB-044	LB-045
Material	Aluminium Die-Cast	Aluminium Die-Cast	Aluminium Die-Cast
Finish	Graphite Black	Graphite Black	Graphite Black
Power Watt.	18W	18W	18W
Input Voltage	230v - 240v - 50Hz	230v - 240v - 50Hz	230v - 240v - 50Hz
Light Source	3 x 6W COB	3 x 6W COB	3 x 6W COB
Lumens Flux	891 LM	891 LM	891 LM
CCT	3000K	3000K	3000K
Beam Angle	28°	28°	28°
IP Rating	IP54	IP54	IP54

- LB-043** - Bollard - Smaller
- LB-044** - Bollard - Medium
- LB-045** - Bollard - Maxi

Powered by: **CREE** LEDs

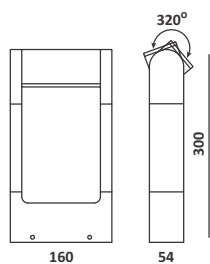

LB-063

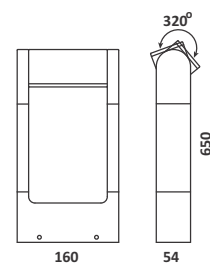

LB-064

Model No.	LB-063	LB-064
Material	Aluminium Die-Cast	Aluminium Die-Cast
Finish	Graphite Black	Graphite Black
Power Watt.	6W	6W
Input Voltage	230v - 240v - 50Hz	230v - 240v - 50Hz
Light Source	18 x SMD	18 x SMD
Lumens Flux	404 LM	404 LM
CCT	3000K	3000K
Beam Angle	111°	111°
IP Rating	IP54	IP54

LB-063 - Bollard - Mini - Adjustable

LB-064 - Bollard - Maxi - Adjustable

Powered by: **CREE** LEDs

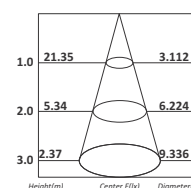

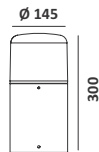

LB-069

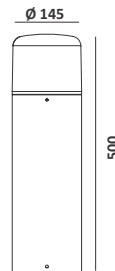

LB-070

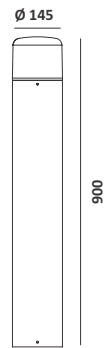

LB-071

Model No.	LB-069	LB-070	LB-071
Material	Aluminium Die-Cast	Aluminium Die-Cast	Aluminium Die-Cast
Finish	Graphite Black	Graphite Black	Graphite Black
Power Watt.	9W	9W	9W
Input Voltage	230v - 240v - 50Hz	230v - 240v - 50Hz	230v - 240v - 50Hz
Light Source	27 x SMD	27 x SMD	27 x SMD
Lumens Flux	807 LM	807 LM	807 LM
CCT	3000K	3000K	3000K
Beam Angle	360°	360°	360°
IP Rating	IP54	IP54	IP54

- LB-069** - Bollard - Mini
- LB-070** - Bollard - Medium
- LB-071** - Bollard - Maxi

Powered by: **CREE** LEDs

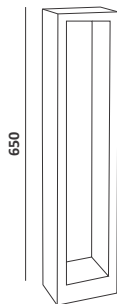

LB-088

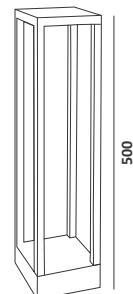

LB-096

Model No.	LB-088	LB-096
Material	Aluminium Die-Cast	Aluminium Die-Cast
Finish	Graphite Black	Graphite Black
Power Watt.	10W	15W
Input Voltage	230v - 240v - 50Hz	230v - 240v - 50Hz
Light Source	24 LED SMD	15W LED
Lumens Flux	870 LM	1125 LM
CCT	3000K	3000K
Beam Angle	73°	73°
IP Rating	IP54	IP54

- LB-088** - Bollard - Maxi
- LB-096** - Bollard - Medium
- LB-097** - Bollard with Solar Panel - Medium

Powered by: **CREE** LEDs



LB-093



LB-094

Model No.	LB-093	LB-094
Material	Aluminium Die-Cast	Aluminium Die-Cast
Finish	Graphite Black	Graphite Black
Power Watt.	15W	15W
Input Voltage	230v - 240v - 50Hz	230v - 240v - 50Hz
Light Source	SMD	SMD
Lumens Flux	722 LM	722 LM
CCT	3000K	3000K
Beam Angle	46°	46°
IP Rating	IP65	IP65

LB-093 - Adjustable Bollard - Medium

LB-094 - Adjustable Bollard - Big

Powered by: **CREE** LEDs

E-27 SURFACE WALL LIGHT & BOLLARDS







LWL-002

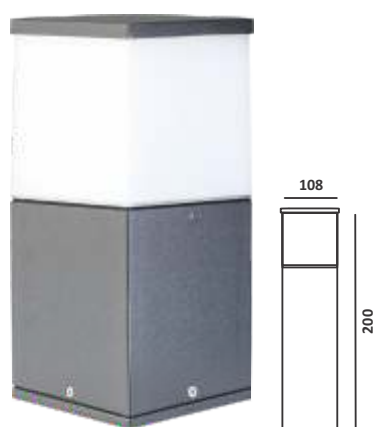

LB-011



LB-012

Model No.	LWL-002	LB-011	LB-012
Material	Aluminium Die-Cast	Aluminium Die-Cast	Aluminium Die-Cast
Finish	Graphite Black	Graphite Black	Graphite Black
Power Watt.	20W Max	20W Max	20W Max
Input Voltage	230v - 240v - 50Hz	230v - 240v - 50Hz	230v - 240v - 50Hz
Light Source	E27 20W	E27 20W	E27 20W
IP Rating	IP44	IP44	IP44

- LWL-002** - Wall Light
- LB-011** - Bollard & Post Light
- LB-012** - Bollard - Maxi

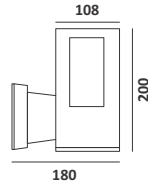

LWL-003

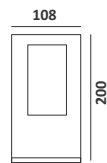

LB-009

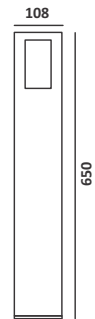

LB-010

Model No.	LWL-003	LB-009	LB-010
Material	Aluminium Die-Cast	Aluminium Die-Cast	Aluminium Die-Cast
Finish	Graphite Black	Graphite Black	Graphite Black
Power Watt.	18W Max	20W Max	20W Max
Input Voltage	230v - 240v - 50Hz	230v - 240v - 50Hz	230v - 240v - 50Hz
Light Source	E27 18W	E27 18W	E27 18W
IP Rating	IP54	IP44	IP44

- LWL-003** - Wall Light
- LB-009** - Bollard - Mini & Post Top
- LB-010** - Bollard - Maxi

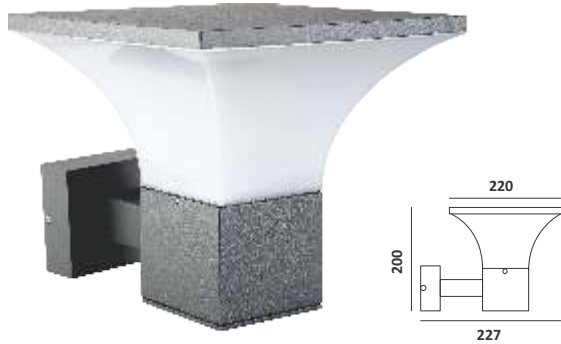

LWL-004



LB-013

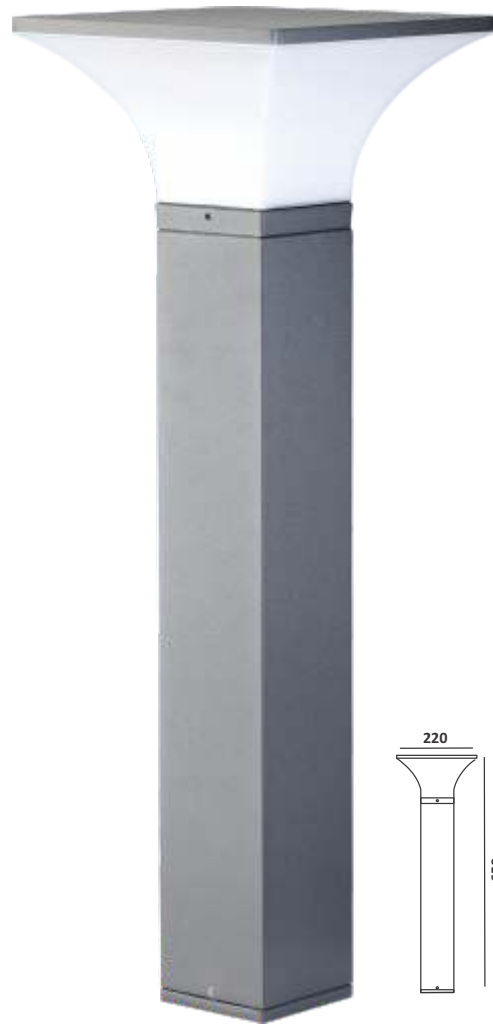

LB-014

Model No.	LWL-004	LB-013	LB-014
Material	Aluminium Die-Cast	Aluminium Die-Cast	Aluminium Die-Cast
Finish	Graphite Black	Graphite Black	Graphite Black
Power Watt.	18W Max	18W Max	18W Max
Input Voltage	230v - 240v - 50Hz	230v - 240v - 50Hz	230v - 240v - 50Hz
Light Source	E27 18W	E27 18W	E27 18W
IP Rating	IP44	IP44	IP44

- LWL-004** - Wall Light
- LB-013** - Bollard - Mini
- LB-014** - Bollard - Maxi

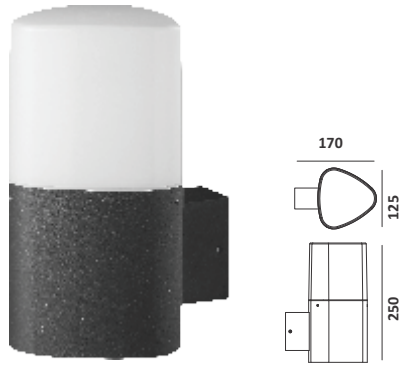

LWL-007



LB-026

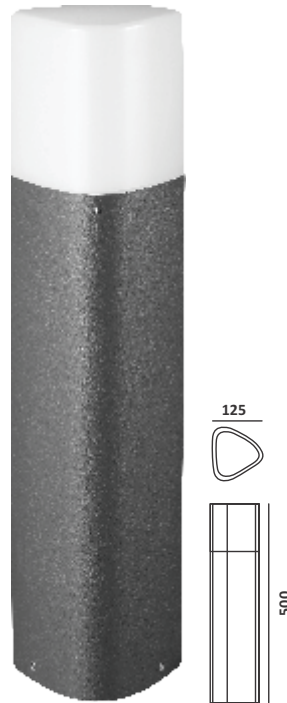

LB-027



LB-028

Model No.	LWL-007	LB-026	LB-027	LB-028
Material	Aluminium Die-Cast	Aluminium Die-Cast	Aluminium Die-Cast	Aluminium Die-Cast
Finish	Graphite Black	Graphite Black	Graphite Black	Graphite Black
Power Watt.	23W Max	23W Max	23W Max	23W Max
Input Voltage	230v - 240v - 50Hz	230v - 240v - 50Hz	230v - 240v - 50Hz	230v - 240v - 50Hz
Light Source	E27 23W	E27 23W	E27 23W	E27 23W
IP Rating	IP54	IP44	IP44	IP44

- LWL-007** - Wall Light
- LB-026** - Bollard - Small
- LB-027** - Bollard - Medium
- LB-028** - Bollard - Large

**TRIANGLE
BIG**



LWL-008



LB-029

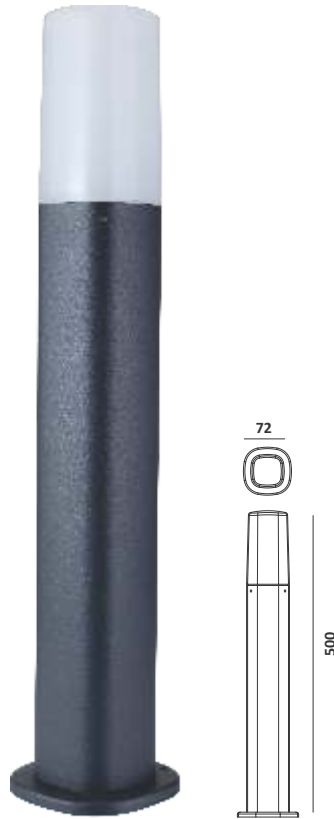

LB-029A

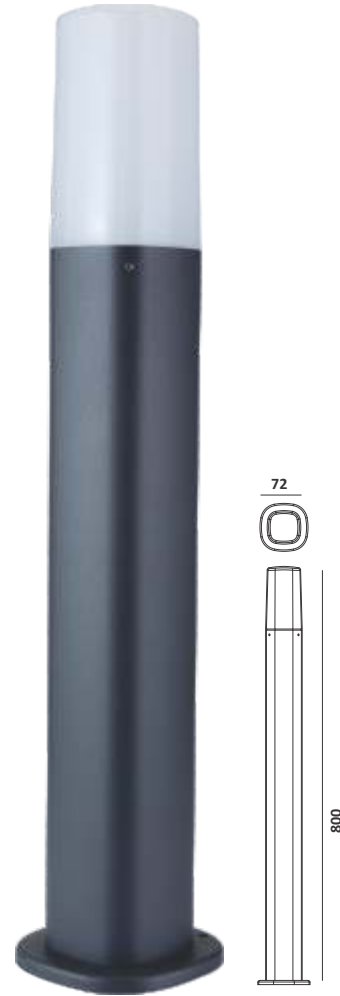

LB-029B

Model No.	LWL-008	LB-029	LB-029A	LB-029B
Material	Aluminium Die-Cast	Aluminium Die-Cast	Aluminium Die-Cast	Aluminium Die-Cast
Finish	Graphite Black	Graphite Black	Graphite Black	Graphite Black
Power Watt.	18W Max	18W Max	18W Max	18W Max
Input Voltage	230v - 240v - 50Hz	230v - 240v - 50Hz	230v - 240v - 50Hz	230v - 240v - 50Hz
Light Source	E27 18W	E27 18W	E27 18W	E27 18W
IP Rating	IP44	IP44	IP44	IP44

- LWL-008** - Wall Light
- LB-029** - Bollard - Small
- LB-029A** - Bollard - Medium
- LB-029B** - Bollard - Large

**SQUARE
SLIM**

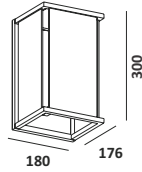

LWL-010

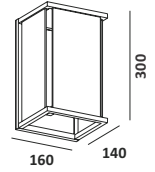

LWL-011

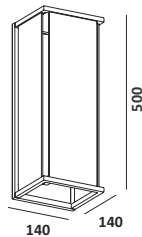

LB-089

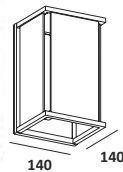

LB-090

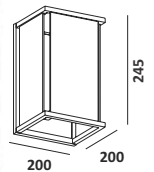

LB-091

Model No.	LWL-010	LWL-011	LB-089	LB-090	LB-091
Material	Aluminium Die-Cast	Aluminium Die-Cast	Aluminium Die-Cast	Aluminium Die-Cast	Aluminium Die-Cas
Finish	Graphite Black	Graphite Black	Graphite Black	Graphite Black	Graphite Black
Power Watt.	15W Max	15W Max	15W Max	15W Max	15W Max
Input Voltage	230v - 240v - 50Hz	230v - 240v - 50Hz	230v - 240v - 50Hz	230v - 240v - 50Hz	230v - 240v - 50Hz
Light Source	E27 15W	E27 15W	E27 15W	E27 15W	E27 15W
IP Rating	IP54	IP54	IP54	IP54	IP54

- LWL-010** - Wall Light
- LWL-011** - Wall Light
- LB-089** - Max. Bollard - Maxi
- LB-090** - Max. Bollard - Maxi
- LB-091** - Gate Top Light

IP 54 Holder



LWL-033



LB-007

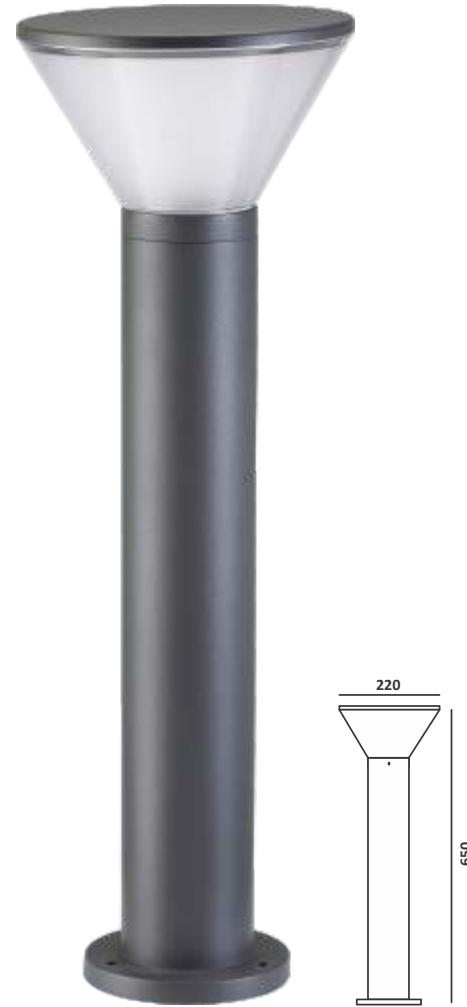

LB-008

Model No.	LWL-033	LB-007	LB-008
Material	Aluminium Die-Cast	Aluminium Die-Cast	Aluminium Die-Cast
Finish	Graphite Black	Graphite Black	Graphite Black
Power Watt.	18W Max	18W Max	18W Max
Input Voltage	230v - 240v - 50Hz	230v - 240v - 50Hz	230v - 240v - 50Hz
Light Source	E27 18W	E27 18W	E27 18W
IP Rating	IP44	IP44	IP44

- LWL-033** - Wall Light
- LB-007** - Bollard - Mini
- LB-008** - Bollard - Maxi

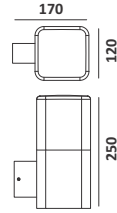

LWL-035

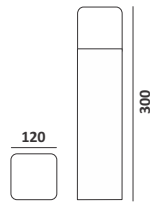

LB-018

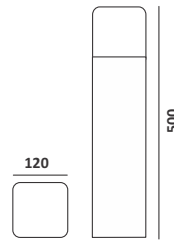

LB-019

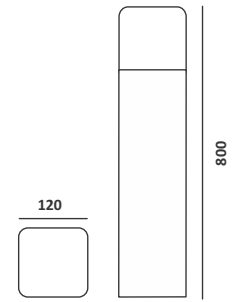

LB-020

Model No.	LWL-035	LB-018	LB-019	LB-020
Material	Aluminium Die-Cast	Aluminium Die-Cast	Aluminium Die-Cast	Aluminium Die-Cast
Finish	Graphite Black	Graphite Black	Graphite Black	Graphite Black
Power Watt.	23W Max	23W Max	23W Max	23W Max
Input Voltage	230v - 240v - 50Hz	230v - 240v - 50Hz	230v - 240v - 50Hz	230v - 240v - 50Hz
Light Source	E27 23W	E27 23W	E27 23W	E27 23W
IP Rating	IP44	IP44	IP44	IP44

- LWL-035** - Square Wall Light
- LB-018** - Bollard - Small
- LB-019** - Bollard - Medium
- LB-020** - Bollard - Large

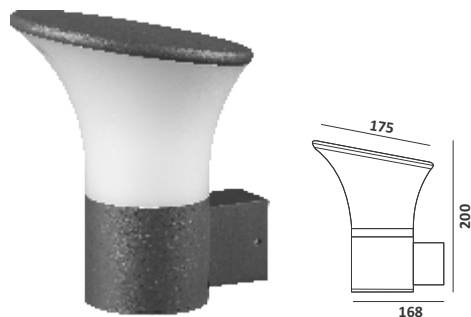

LWL-036



LB-015



LB-016



LB-017

Model No.	LWL-036	LB-015	LB-016	LB-017
Material	Aluminium Die-Cast	Aluminium Die-Cast	Aluminium Die-Cast	Aluminium Die-Cast
Finish	Graphite Black	Graphite Black	Graphite Black	Graphite Black
Power Watt.	23W Max	23W Max	23W Max	23W Max
Input Voltage	230v - 240v - 50Hz	230v - 240v - 50Hz	230v - 240v - 50Hz	230v - 240v - 50Hz
Light Source	E27 23W	E27 23W	E27 23W	E27 23W
IP Rating	IP44	IP44	IP44	IP44

- LWL-036** - Wall Light
- LB-015** - Bollard - Small
- LB-016** - Bollard - Medium
- LB-017** - Bollard - Large



LWL-037



LB-023



LB-024



LB-025

Model No.	LWL-037	LB-023	LB-024	LB-025
Material	Aluminium Die-Cast	Aluminium Die-Cast	Aluminium Die-Cast	Aluminium Die-Cast
Finish	Graphite Black	Graphite Black	Graphite Black	Graphite Black
Power Watt.	23W Max	23W Max	23W Max	23W Max
Input Voltage	230v - 240v - 50Hz	230v - 240v - 50Hz	230v - 240v - 50Hz	230v - 240v - 50Hz
Light Source	E27 23W	E27 23W	E27 23W	E27 23W
IP Rating	IP44	IP44	IP44	IP44

- LWL-037** - Wall Light
- LB-023** - Bollard - Small
- LB-024** - Bollard - Medium
- LB-025** - Bollard - Large



LB-001

LB-002

LB-003

LB-004

Model No.	LB-001	LB-002	LB-003	LB-004
Material	Aluminium Die-Cast	Aluminium Die-Cast	Aluminium Die-Cast	Aluminium Die-Cast
Finish	Graphite Black	Graphite Black	Graphite Black	Graphite Black
Power Watt.	18W Max	18W Max	18W Max	18W Max
Input Voltage	230v - 240v - 50Hz	230v - 240v - 50Hz	230v - 240v - 50Hz	230v - 240v - 50Hz
Light Source	E27 18W	E27 18W	E27 60W	E27 60W
IP Rating	IP44	IP44	IP44	IP44

- LB-001** - Bollard / Post Top - Mini
- LB-002** - Bollard - Maxi
- LB-003** - Bollard / Post Top - Mini
- LB-004** - Bollard - Maxi



LB-103



LB-104

Model No.	LB-103	LB-104
Material	Aluminium Die-Cast	Aluminium Die-Cast
Finish	Graphite Black	Graphite Black
Power Watt.	20W Max	20W Max
Input Voltage	230v - 240v - 50Hz	230v - 240v - 50Hz
Light Source	E27 20W	E27 20W
IP Rating	IP44	IP44

- LB-103** - Bollard - Medium
- LB-104** - Bollard - Maxi

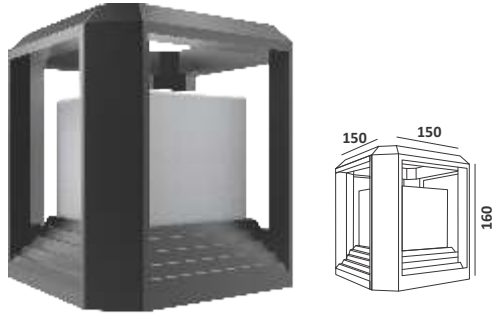

LB-021

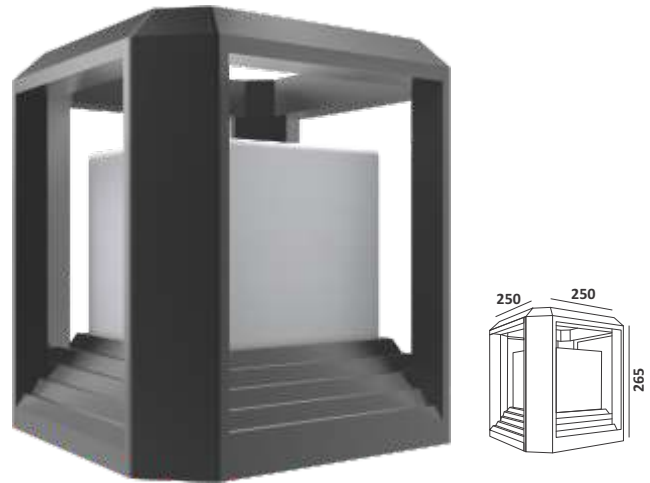

LB-022

Model No.	LB-021	LB-022
Material	Aluminium Die-Cast	Aluminium Die-Cast
Finish	Graphite Black	Graphite Black
Power Watt.	12W Max	23W Max
Input Voltage	230v - 240v - 50Hz	230v - 240v - 50Hz
Light Source	E27 12W	E27 23W
IP Rating	IP65	IP65

LB-021 - Gate Top Light - Small

LB-022 - Gate Top Light - Big

E-27 SURFACE WALL LIGHT & BOLLARDS

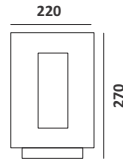

Description : Gate Top Light
Material : Aluminium Die-Cast
Finish : Graphite Black
Power Watt. : 26W Max
Input Voltage : 230v - 240v - 50Hz
Light Source : E27 | 26W
IP Rating : IP44

LB-005

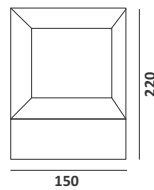

Description : Gate Top Light
Material : Aluminium Die-Cast
Finish : Graphite Black
Power Watt. : 18W Max
Input Voltage : 230v - 240v - 50Hz
Light Source : E27 | 18W
IP Rating : IP44

LB-006

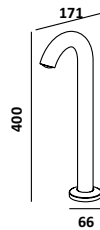

Description : Mini Bollard
Material : Aluminium Die-Cast
Finish : Graphite Black
Power Watt. : 4W
Input Voltage : 230v - 240v - 50Hz
Light Source : 1 x 4W
Lumens Flux : 317 LM
CCT : 3000K
Beam Angle : 70°
IP Rating : IP65

LB-095

Powered by: **CREE** LEDs

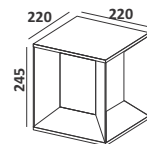

Description : Wall & Post Light
Material : Aluminium Die-Cast
Finish : Graphite Black
Power Watt. : 18W
Input Voltage : 230v - 240v - 50Hz
Light Source : SMD
Lumens Flux : 737 LM
CCT : 3000K
Beam Angle : 81°
IP Rating : IP65

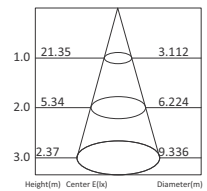

LB-099

Powered by: **CREE** LEDs

POLE LIGHTS





LPL-001



LPL-002

Model No.	LPL-001	LPL-002
Material	Aluminium Die-Cast	Aluminium Die-Cast
Finish	Graphite Black	Graphite Black
Power Watt.	18W	2 x 18W
Input Voltage	230v - 240v - 50Hz	230v - 240v - 50Hz
Light Source	E27 18W	E27 2x18W
IP Rating	IP54	IP54

- LPL-001** - Victorian Pole Light - Single
- LPL-002** - Victorian Pole Light - Double



LPL-003

Model No.	LPL-003
Material	Aluminium Die-Cast
Finish	Graphite Black
Power Watt.	18W
Input Voltage	230v - 240v - 50Hz
Light Source	E27 18W
IP Rating	IP54

LPL-003 - Victorian Pole Light

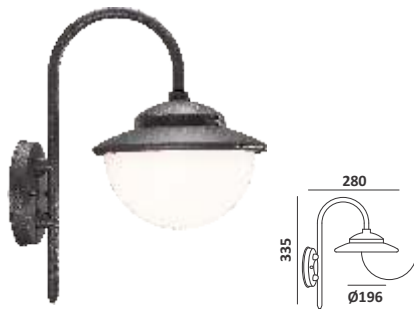

LLO-072

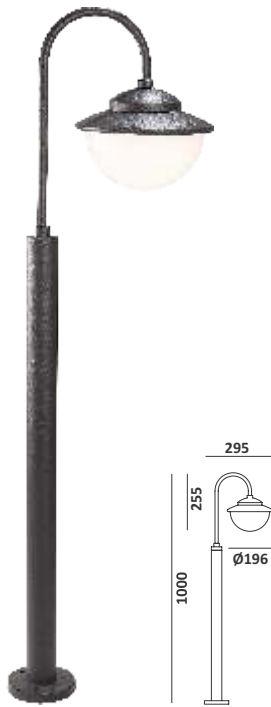

LPL-004

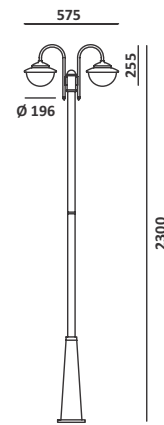

LPL-005

Model No.	LLO-072	LPL-004	LPL-005
Material	Aluminium Die-Cast	Aluminium Die-Cast	Aluminium Die-Cast
Finish	Graphite Black	Graphite Black	Graphite Black
Power Watt.	9W	9W	2 x 9W
Input Voltage	230v - 240v - 50Hz	230v - 240v - 50Hz	230v - 240v - 50Hz
Light Source	27 x SMD	27 x SMD	54 x SMD
Lumens Flux	776 LM	776 LM	1552 LM
CCT	3000K	3000K	3000K
Beam Angle	132°	132°	132°
IP Rating	IP54	IP54	IP54

- LLO-072** - Wall Light
- LPL-004** - Pole Light - Single
- LPL-005** - Pole Light - Double

Powered by: **CREE** LEDs



Model No.	LPL-006	LPL-007	LPL-008
Material	Aluminium Die-Cast	Aluminium Die-Cast	Aluminium Die-Cast
Finish	Graphite Black	Graphite Black	Graphite Black
Power Watt.	18W	27W	9W
Input Voltage	230v - 240v - 50Hz	230v - 240v - 50Hz	230v - 240v - 50Hz
Light Source	180 x SMD	270 x SMD	90 x SMD
Lumens Flux	866 LM	1299 LM	433 LM
CCT	3000K	3000K	3000K
Beam Angle	112°	112°	112°
IP Rating	IP54	IP54	IP54

- LPL-006** - Pole Light - Medium
- LPL-007** - Pole Light - Maxi
- LPL-008** - Pole Light - Mini

Powered by: **CREE** LEDs



LPL-009



LPL-010

Model No.	LPL-009	LPL-010
Material	Aluminium Die-Cast	Aluminium Die-Cast
Finish	Graphite Black	Graphite Black
Power Watt.	15W	24W
Input Voltage	230v - 240v - 50Hz	230v - 240v - 50Hz
Light Source	3 x 5W SMD	12 x 2W LED
Lumens Flux	1080 LM	732 LM
CCT	3000K	3000K
Beam Angle	132°	54°
IP Rating	IP54	IP54

LPL-009 - Pole Light

LPL-010 - Pole Light

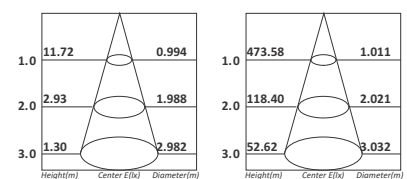

Powered by: **CREE** LEDs

E-27 OUTDOOR SURFACE WALL LIGHT





E-27 OUTDOOR SURFACE WALL LIGHT

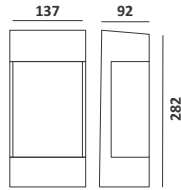

Description : Wall Light
Material : Aluminium Die-Cast
Finish : Graphite Black
Power Watt. : 18W Max
Input Voltage : 230v - 240v - 50Hz
Light Source : E27 | 18W
IP Rating : IP54

LWL-001

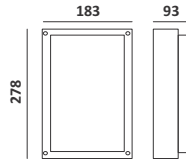

Description : Wall Light
Material : Aluminium Die-Cast
Finish : Graphite Black
Power Watt. : 18W Max
Input Voltage : 230v - 240v - 50Hz
Light Source : E27 | 18W
IP Rating : IP54

LWL-005

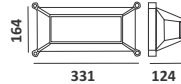

Description : Wall Light - Protruding Rectangular
Material : Aluminium Die-Cast
Finish : Graphite Black
Power Watt. : 18W Max
Input Voltage : 230v - 240v - 50Hz
Light Source : E27 | 18W
IP Rating : IP54

LWL-006

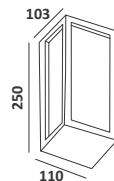

Description : Wall Light
Material : Aluminium Die-Cast
Finish : Graphite Black
Power Watt. : 18W Max
Input Voltage : 230v - 240v - 50Hz
Light Source : E27 | 18W
IP Rating : IP54

LWL-009

E-27 OUTDOOR SURFACE WALL LIGHT

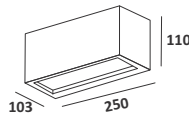

Description : Wall Light
Material : Aluminium Die-Cast
Finish : Graphite Black
Power Watt. : 18W Max
Input Voltage : 230v - 240v - 50Hz
Light Source : E27 | 18W
IP Rating : IP44

LWL-012

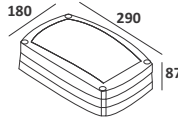

Description : Wall Light
Material : Aluminium Die-Cast
Finish : Graphite Black
Power Watt. : 18W Max
Input Voltage : 230v - 240v - 50Hz
Light Source : E27 | 18W
IP Rating : IP44

LWL-013

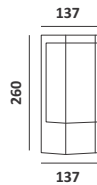

Description : Wall Light
Material : Aluminium Die-Cast
Finish : Graphite Black
Power Watt. : 20W Max
Input Voltage : 230v - 240v - 50Hz
Light Source : E27 | 18W
IP Rating : IP44

LWL-014

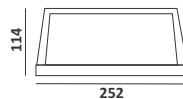

Description : Wall Light - Rectangular
Material : Aluminium Die-Cast
Finish : Graphite Black
Power Watt. : 18W Max
Input Voltage : 230v - 240v - 50Hz
Light Source : E27 | 18W
IP Rating : :54

LWL-015

E-27 OUTDOOR SURFACE WALL LIGHT

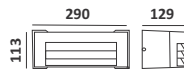

Description : Horizontal Wall Light with Louvre
Material : Aluminium Die-Cast
Finish : Graphite Black
Power Watt. : 18W Max
Input Voltage : 230v - 240v - 50Hz
Light Source : E27 | 18W
IP Rating : IP54

LWL-016

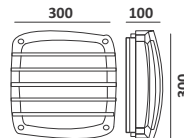

Description : Wall & Ceiling Light - Square
Material : Aluminium Die-Cast
Finish : Graphite Black
Power Watt. : 18W Max
Input Voltage : 230v - 240v - 50Hz
Light Source : E27 | 18W
IP Rating : IP54

LWL-017

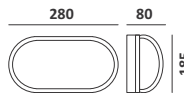

Description : Wall Light - Oval
Material : Aluminium Die-Cast
Finish : Graphite Black
Power Watt. : 18W Max
Input Voltage : 230v - 240v - 50Hz
Light Source : E27 | 18W
IP Rating : IP44

LWL-020

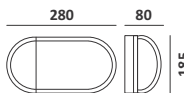

Description : Wall Light - Oval Half Covered
Material : Aluminium Die-Cast
Finish : Graphite Black
Power Watt. : 18W Max
Input Voltage : 230v - 240v - 50Hz
Light Source : E27 | 18W
IP Rating : IP44

LWL-021

E-27 OUTDOOR SURFACE WALL LIGHT

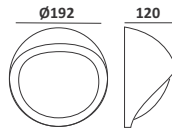

Description : Wall Light - Round Protruder
Material : Aluminium Die-Cast
Finish : Graphite Black
Power Watt. : 18W Max
Input Voltage : 230v - 240v - 50Hz
Light Source : E27 | 18W
IP Rating : IP54

LWL-022

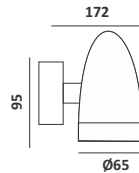

Description : Spot Light
Material : Aluminium Die-Cast
Finish : Graphite Black
Power Watt. : 35W Max
Input Voltage : 230v - 240v - 50Hz
Light Source : Gu10 | 35W
IP Rating : IP54

LWL-023

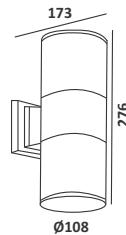

Description : Up Down Wall Light
Material : Aluminium Die-Cast
Finish : Graphite Black
Power Watt. : 60W Max
Input Voltage : 230v - 240v - 50Hz
Light Source : E27 | 2 x 30W
IP Rating : IP44

LWL-024

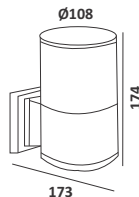

Description : Up Or Down Wall Light
Material : Aluminium Die-Cast
Finish : Graphite Black
Power Watt. : 60W Max
Input Voltage : 230v - 240v - 50Hz
Light Source : E27 | 60W
IP Rating : IP54

LWL-025

E-27 OUTDOOR SURFACE WALL LIGHT

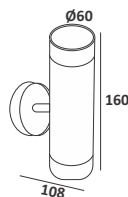

Description : Up Down Wall Light
 Material : Aluminium Die-Cast
 Finish : Stainless
 Power Watt. : 30W Max
 Input Voltage : 230v - 240v - 50Hz
 Light Source : Gu10 | 2 x 15W
 IP Rating : IP54

LWL-026

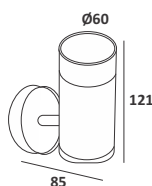

Description : Up / Down Wall Light
 Material : Aluminium Die-Cast
 Finish : Stainless
 Power Watt. : 15W Max
 Input Voltage : 230v - 240v - 50Hz
 Light Source : Gu10 | 1x15W
 IP Rating : IP54

LWL-027

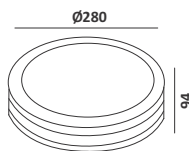

Description : Wall Light
 Material : Aluminium Die-Cast
 Finish : Graphite Black
 Power Watt. : 18W Max
 Input Voltage : 230v - 240v - 50Hz
 Light Source : E27 | 18W
 IP Rating : IP44

LWL-028

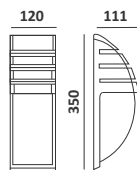

Description : Bulk Head - Semi Circle
 Material : Aluminium Die-Cast
 Finish : Graphite Black
 Power Watt. : 18W Max
 Input Voltage : 230v - 240v - 50Hz
 Light Source : E27 | 18W
 IP Rating : IP54

LWL-029

E-27 OUTDOOR SURFACE WALL LIGHT

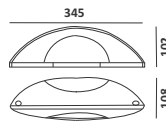

Description : Up / Down Wall Light
Material : Aluminium Die-Cast
Finish : Graphite Black
Power Watt. : 18W Max
Input Voltage : 230v - 240v - 50Hz
Light Source : E27 | 18W
IP Rating : IP54

LWL-030

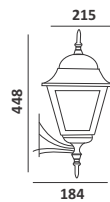

Description : Victorian Wall Light
Material : Aluminium Die-Cast
Finish : Graphite Black
Power Watt. : 18W Max
Input Voltage : 230v - 240v - 50Hz
Light Source : E27 | 18W
IP Rating : IP44

LWL-031

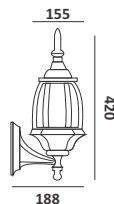

Description : Victorian Wall Light
Material : Aluminium Die-Cast
Finish : Graphite Black
Power Watt. : 18W Max
Input Voltage : 230v - 240v - 50Hz
Light Source : E27 | 18W
IP Rating : IP54

LWL-032

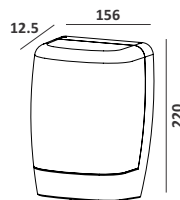

Description : Wall Light
Material : Aluminium Die-Cast
Finish : Graphite Black
Power Watt. : 18W Max
Input Voltage : 230v - 240v - 50Hz
Light Source : E27 | 18W
IP Rating : IP44

LWL-034

OUTDOOR GATE LIGHTS





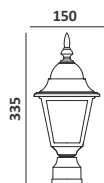

Description : Victorian Gate Light
 Material : Aluminium Die-Cast
 Finish : Graphite Black
 Power Watt. : 18W Max
 Input Voltage : 230v - 240v - 50Hz
 Light Source : E27 | 18W
 IP Rating : IP44

LGL-001

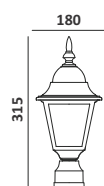

Description : Victorian Gate Light
 Material : Aluminium Die-Cast
 Finish : Graphite Black
 Power Watt. : 18W Max
 Input Voltage : 230v - 240v - 50Hz
 Light Source : E27 | 18W
 IP Rating : IP44

LGL-002

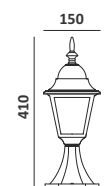

Description : Victorian Gate Light
 Material : Aluminium Die-Cast
 Finish : Graphite Black
 Power Watt. : 18W Max
 Input Voltage : 230v - 240v - 50Hz
 Light Source : E27 | 18W
 IP Rating : IP44

LGL-003

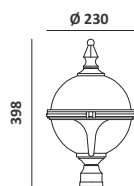

Description : Victorian Gate Light
 Material : Aluminium Die-Cast
 Finish : Graphite Black
 Power Watt. : 18W Max
 Input Voltage : 230v - 240v - 50Hz
 Light Source : E27 | 18W
 IP Rating : IP44

LGL-004

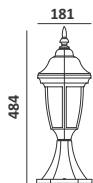

Description : Victorian Gate Light
 Material : Aluminium Die-Cast
 Finish : Graphite Black
 Power Watt. : 18W Max
 Input Voltage : 230v - 240v - 50Hz
 Light Source : E27 | 18W
 IP Rating : IP44

LGL-005

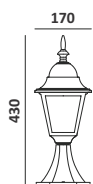

Description : Victorian Gate Light
 Material : Aluminium Die-Cast
 Finish : Graphite Black
 Power Watt. : 18W Max
 Input Voltage : 230v - 240v - 50Hz
 Light Source : E27 | 18W
 IP Rating : IP44

LGL-006



E-27 OUTDOOR BULK HEADS





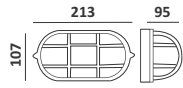

Description : Plain Bulk Head - Oval
 Material : Aluminium Die-Cast
 Finish : Graphite Black
 Power Watt. : 18W Max
 Input Voltage : 230v - 240v - 50Hz
 Light Source : E27 | 18W
 IP Rating : IP54

LBH-001

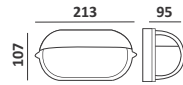

Description : Half Covered Bulk Head - Oval
 Material : Aluminium Die-Cast
 Finish : Graphite Black
 Power Watt. : 18W Max
 Input Voltage : 230v - 240v - 50Hz
 Light Source : E27 | 18W
 IP Rating : IP54

LBH-002

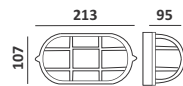

Description : Bulk Head with Grill - Oval
 Material : Aluminium Die-Cast
 Finish : Graphite Black
 Power Watt. : 18W Max
 Input Voltage : 230v - 240v - 50Hz
 Light Source : E27 | 18W
 IP Rating : IP54

LBH-003

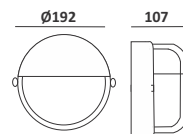

Description : Half Covered Bulk Head - Round
 Material : Aluminium Die-Cast
 Finish : Graphite Black
 Power Watt. : 18W Max
 Input Voltage : 230v - 240v - 50Hz
 Light Source : E27 | 18W
 IP Rating : IP54

LBH-004

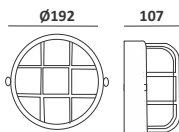

Description : Plain Bulk Head - Round
 Material : Aluminium Die-Cast
 Finish : Graphite Black
 Power Watt. : 18W Max
 Input Voltage : 230v - 240v - 50Hz
 Light Source : E27 | 18W
 IP Rating : IP54

LBH-005

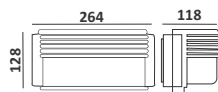

Description : Bulk Head with Grill - Rectangular
 Material : Aluminium Die-Cast
 Finish : Graphite Black
 Power Watt. : 18W Max
 Input Voltage : 230v - 240v - 50Hz
 Light Source : E27 | 18W
 IP Rating : IP54

LBH-007

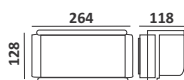

Description : Plain Bulk Head - Rectangular
 Material : Aluminium Die-Cast
 Finish : Graphite Black
 Power Watt. : 18W Max
 Input Voltage : 230v - 240v - 50Hz
 Light Source : E27 | 18W
 IP Rating : IP54

LBH-008

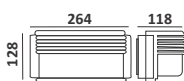

Description : Half Covered Bulk Head - Rectangular
 Material : Aluminium Die-Cast
 Finish : Graphite Black
 Power Watt. : 18W Max
 Input Voltage : 230v - 240v - 50Hz
 Light Source : E27 | 18W
 IP Rating : IP54

LBH-009

E-27 OUTDOOR CONCEALED WALL LIGHTS





E-27 OUTDOOR CONCEALED WALL LIGHTS

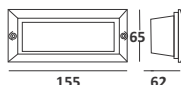

Description : Wall Light
Material : Aluminium Die-Cast
Finish : Sand Grey
Power Watt. : 18W Max
Input Voltage : 230v - 240v - 50Hz
Light Source : E27 | 18W
IP Rating : IP54

LCWL-001

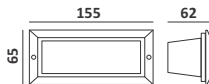

Description : Wall Light
Material : Aluminium Die-Cast
Finish : Graphite Black
Power Watt. : 18W Max
Input Voltage : 230v - 240v - 50Hz
Light Source : E27 | 18W
IP Rating : IP54

LCWL-002

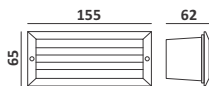

Description : Wall Light with straight louvre
Material : Aluminium Die-Cast
Finish : Sand Grey
Power Watt. : 18W Max
Input Voltage : 230v - 240v - 50Hz
Light Source : E27 | 18W
IP Rating : IP54

LCWL-003

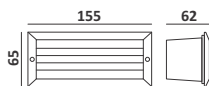

Description : Wall Light with straight louvre
Material : Aluminium Die-Cast
Finish : Graphite Black
Power Watt. : 18W Max
Input Voltage : 230v - 240v - 50Hz
Light Source : E27 | 18W
IP Rating : IP54

LCWL-004

E-27 OUTDOOR CONCEALED WALL LIGHTS

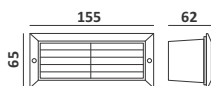

Description : Wall Light with angled louvre
Material : Aluminium Die-Cast
Finish : Sand Grey
Power Watt. : 18W Max
Input Voltage : 230v - 240v - 50Hz
Light Source : E27 | 18W
IP Rating : IP44

LCWL-005

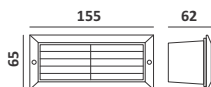

Description : Wall Light with angled louvre
Material : Aluminium Die-Cast
Finish : Graphite Black
Power Watt. : 18W Max
Input Voltage : 230v - 240v - 50Hz
Light Source : E27 | 18W
IP Rating : IP44

LCWL-006



GU10 OUTDOOR IN GROUND LIGHTS



GU10 OUTDOOR IN GROUND LIGHTS

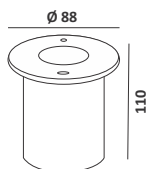

Description : In Ground/ Driver Over Light - Round
 Material : Aluminium Die-Cast
 Finish : Stainless
 Power Watt. : 50W Max
 Input Voltage : 230v - 240v - 50Hz
 Light Source : Gu10 | 50W
 IP Rating : IP54

LUG-001

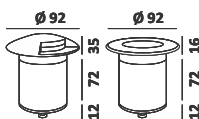

Description : In Ground/ Driver Over Light -
 Material : Aluminium Die-Cast
 Finish : Stainless
 Power Watt. : 50W Max
 Input Voltage : 230v - 240v - 50Hz
 Light Source : Gu10 | 50W
 IP Rating : IP54

LUG-002 - 4 Way Round
LUG-003 - 2 Way Round

LUG-002 / 003

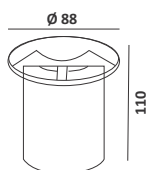

Description : In Ground / Walk Over Light - 4 Way Round
 Material : Aluminium Die-Cast
 Finish : Graphite Black
 Power Watt. : 50W Max
 Input Voltage : 230v - 240v - 50Hz
 Light Source : Gu10 | 50W
 IP Rating : IP54

LUG-004 - 4 Way Round
LUG-005 - 2 Way Round

LUG-004 / 005



GU10 GARDEN SPIKE LIGHTS



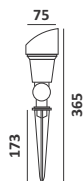

Description : Fountain Spot Light with Spike
Material : Aluminium Die-Cast
Finish : Graphite Black
Power Watt. : 35W Max
Input Voltage : 230v - 240v - 50Hz
Light Source : GU10 | 35W
IP Rating : IP65

LGLS-001

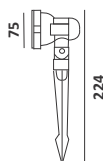

Description : Fountain Spot Light with Spike
Material : Aluminium Die-Cast
Finish : Graphite Black
Power Watt. : 35W Max
Input Voltage : 230v - 240v - 50Hz
Light Source : GU10 | 35W
IP Rating : IP54

LGLS-002



LED LUM ECO SERIES OUTDOOR LIGHTS





LED LUM ECO SERIES OUTDOOR LIGHTS

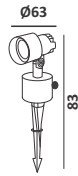

Description : Spot Light with Spike
 Material : Aluminium Die-Cast
 Finish : Graphite Black
 Power Watt. : 6W
 Input Voltage : 230v - 240v - 50Hz
 Light Source : 1 x 6W COB
 Lumens Flux : 480 LM
 CCT : 3000K
 Beam Angle : 15° / 36°
 IP Rating : IP44

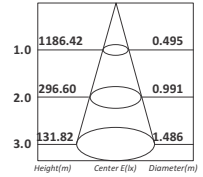

LEO-001

Powered by: **CREE** LEDs

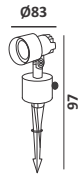

Description : Spot Light with Spike
 Material : Aluminium Die-Cast
 Finish : Graphite Black
 Power Watt. : 12W
 Input Voltage : 230v - 240v - 50Hz
 Light Source : 1 x 12W COB
 Lumens Flux : 960 LM
 CCT : 3000K
 Beam Angle : 15° / 36°
 IP Rating : IP44

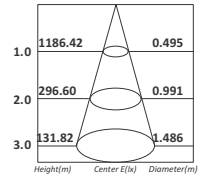

LEO-002

Powered by: **CREE** LEDs

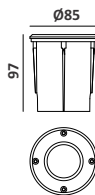

Description : Driver Over Underground Light
 Material : Aluminium Die-Cast
 Finish : Graphite Black
 Power Watt. : 6W
 Input Voltage : 230v - 240v - 50Hz
 Light Source : 1 x 6W COB
 Lumens Flux : 480 LM
 CCT : 3000K
 Beam Angle : 15° / 36°
 IP Rating : IP44

LEO-003

Powered by: **CREE** LEDs

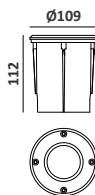

Description : Driver Over Underground Light
 Material : Aluminium Die-Cast
 Finish : Graphite Black
 Power Watt. : 12W
 Input Voltage : 230v - 240v - 50Hz
 Light Source : 1 x 12W COB
 Lumens Flux : 480 LM
 CCT : 3000K
 Beam Angle : 15° / 36°
 IP Rating : IP44

LEO-004

Powered by: **CREE** LEDs

LED LUM ECO SERIES OUTDOOR LIGHTS

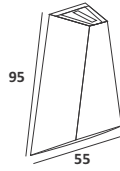

Description : Up Down Wall Light
 Material : Aluminium Die-Cast
 Finish : Graphite Black
 Power Watt. : 6W
 Input Voltage : 230v - 240v - 50Hz
 Light Source : 1 x 6W
 Lumens Flux : 480 LM
 CCT : 3000K
 Beam Angle : 15° / 36°
 IP Rating : IP44

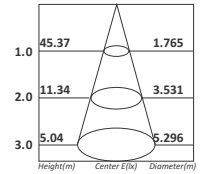

LEO-005

Powered by: **CREE** LEDs

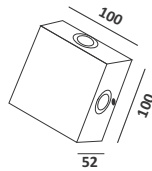
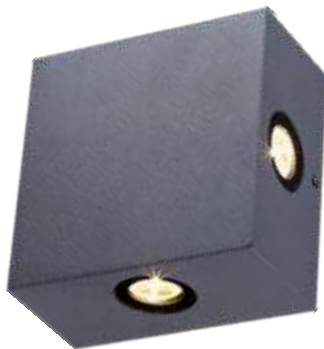

Description : 4-Way Wall Light with Wide Beam Lens
 Material : Aluminium Die-Cast
 Finish : Graphite Black
 Power Watt. : 16W
 Input Voltage : 230v - 240v - 50Hz
 Light Source : 4 x 3W COB
 Lumens Flux : 960 LM
 CCT : 3000K
 Beam Angle : 15° / 36°
 IP Rating : IP44

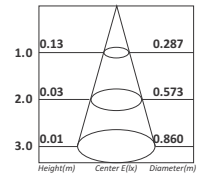

LEO-006

Powered by: **CREE** LEDs

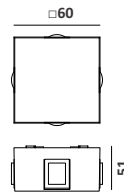

Description : 4-Way Streak Wall Light with Narrow Beam Lens
 Material : Aluminium Die-Cast
 Finish : Graphite Black
 Power Watt. : 12W
 Input Voltage : 230v - 240v - 50Hz
 Light Source : 4 x 3W COB
 Lumens Flux : 960 LM
 CCT : 3000K
 Beam Angle : 15° / 36°
 IP Rating : IP44

LEO-007

Powered by: **CREE** LEDs

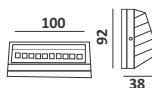

Description : Wall Light
 Material : Aluminium Die-Cast
 Finish : Graphite Black
 Power Watt. : 2W
 Input Voltage : 230v - 240v - 50Hz
 Light Source : 2W COB
 Lumens Flux : 160 LM
 CCT : 3000K
 Beam Angle : 120°
 IP Rating : IP44

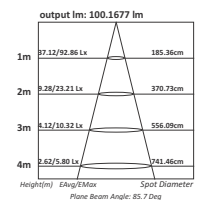

LEO-008

Powered by: **CREE** LEDs

LED LUM ECO SERIES OUTDOOR LIGHTS

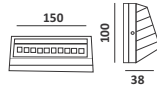

Description : Wall Light
 Material : Aluminium Die-Cast
 Finish : Graphite Black
 Power Watt. : 4W
 Input Voltage : 230v - 240v - 50Hz
 Light Source : 4W COB
 Lumens Flux : 320 LM
 CCT : 3000K
 Beam Angle : 120°
 IP Rating : IP44

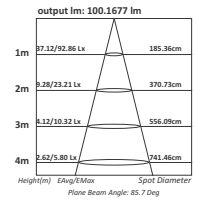

LEO-009

Powered by: **CREE** LEDs

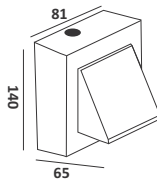

Description : Up or Down Wall Light
 Material : Aluminium Die-Cast
 Finish : Graphite Black
 Power Watt. : 3W
 Input Voltage : 230v - 240v - 50Hz
 Light Source : 1 x 3W COB
 Lumens Flux : 240 LM
 CCT : 3000K
 Beam Angle : 15° / 36°
 IP Rating : IP44

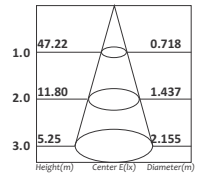

LEO-010

Powered by: **CREE** LEDs

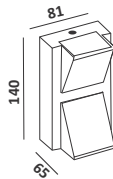

Description : Up Down Wall Light
 Material : Aluminium Die-Cast
 Finish : Graphite Black
 Power Watt. : 6W
 Input Voltage : 230v - 240v - 50Hz
 Light Source : 2 x 3W COB
 Lumens Flux : 480 LM
 CCT : 3000K
 Beam Angle : 15° / 36°
 IP Rating : IP44

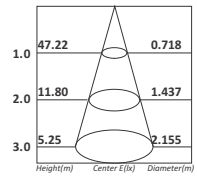

LEO-011

Powered by: **CREE** LEDs

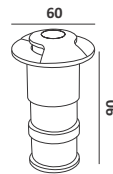

Description : Inground 2-Way Light - Round
 Material : Aluminium Die-Cast
 Finish : Sand Grey
 Power Watt. : 3W
 Input Voltage : 230v - 240v - 50Hz
 Light Source : 3W COB
 Lumens Flux : 300 LM
 CCT : 3000K
 Beam Angle : 60°
 IP Rating : IP54

LEO-012

Powered by: **EPISTAR**



Description : Inground 4-Way Light - Round
 Material : Aluminium Die-Cast
 Finish : Sand Grey
 Power Watt. : 3W
 Input Voltage : 230v - 240v - 50Hz
 Light Source : 3W COB
 Lumens Flux : 300 LM
 CCT : 3000K
 Beam Angle : 60°
 IP Rating : IP54

LEO-013

Powered by: **EPISTAR**

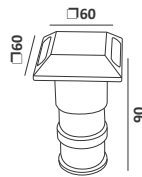

Description : Inground 2-Way Light - Square
 Material : Aluminium Die-Cast
 Finish : Sand Grey
 Power Watt. : 3W
 Input Voltage : 230v - 240v - 50Hz
 Light Source : 3W COB
 Lumens Flux : 300 LM
 CCT : 3000K
 Beam Angle : 60°
 IP Rating : IP54

LEO-014

Powered by: **EPISTAR**

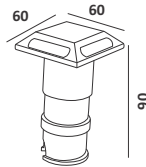

Description : Inground 4-Way Light - Square
 Material : Aluminium Die-Cast
 Finish : Sand Grey
 Power Watt. : 3W
 Input Voltage : 230v - 240v - 50Hz
 Light Source : 3W COB
 Lumens Flux : 300 LM
 CCT : 3000K
 Beam Angle : 60°
 IP Rating : IP54

LEO-015

Powered by: **EPISTAR**

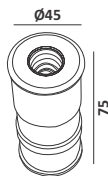

Description : Inground Light - Round
 Material : Aluminium Die-Cast
 Finish : Stainless
 Power Watt. : 3W
 Input Voltage : 230v - 240v - 50Hz
 Light Source : 3W COB
 Lumens Flux : 300 LM
 CCT : 3000K
 Beam Angle : 60°
 IP Rating : IP54

LEO-016

Powered by: **EPISTAR**

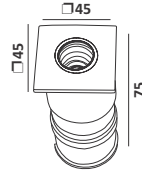

Description : Inground Light - Square
 Material : Aluminium Die-Cast
 Finish : Stainless
 Power Watt. : 3W
 Input Voltage : 230v - 240v - 50Hz
 Light Source : 3W COB
 Lumens Flux : 300 LM
 CCT : 3000K
 Beam Angle : 60°
 IP Rating : IP54

LEO-017

Powered by: **EPISTAR**

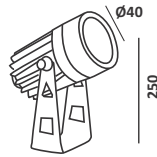

Description : Spot Light with Spike
 Material : Aluminium Die-Cast
 Finish : Graphite Black
 Power Watt. : 3W High Tower
 Input Voltage : 230v - 240v - 50Hz
 Light Source : 1 x 3W LED
 Lumens Flux : 270 LM
 CCT : 3000K
 Beam Angle : 30°
 IP Rating : IP54

LEO-018

Powered by: **EPISTAR**

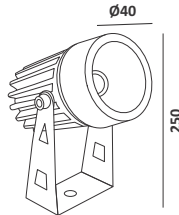

Description : Spot Light with Base
 Material : Aluminium Die-Cast
 Finish : Graphite Black
 Power Watt. : 3W
 Input Voltage : 230v - 240v - 50Hz
 Light Source : 3 x 1W COB
 Lumens Flux : 270 LM
 CCT : 3000K
 Beam Angle : 54°
 IP Rating : IP54

LEO-019

Powered by: **EPISTAR**

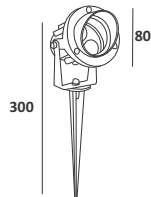

Description : Spot Light with Spike - Hood Type
 Material : Aluminium Die-Cast
 Finish : Graphite Black
 Power Watt. : 3W
 Input Voltage : 230v - 240v - 50Hz
 Light Source : 3 x 1W LED
 Lumens Flux : 270 LM
 CCT : 3000K
 Beam Angle : 30°
 IP Rating : IP54

LEO-020

Powered by: **EPISTAR**



Description : Spot Light with Spike
 Material : Aluminium Die-Cast
 Finish : Graphite Black
 Power Watt. : 5W
 Input Voltage : 230v - 240v - 50Hz
 Light Source : 1 x 5W COB
 Lumens Flux : 450 LM
 CCT : 3000K
 Beam Angle : 60°
 IP Rating : IP54

LEO-021

Powered by: **EPISTAR**



Description : Spot Light with Spike
 Material : Aluminium Die-Cast
 Finish : Graphite Black
 Power Watt. : 7W
 Input Voltage : 230v - 240v - 50Hz
 Light Source : 1 x 7W COB
 Lumens Flux : 630 LM
 CCT : 3000K
 Beam Angle : 60°
 IP Rating : IP54

LEO-022

Powered by: **EPISTAR**



Description : Spot Light with Spike
 Material : Aluminium Die-Cast
 Finish : Graphite Black
 Power Watt. : 10W
 Input Voltage : 230v - 240v - 50Hz
 Light Source : 1 x 10W COB
 Lumens Flux : 900 LM
 CCT : 3000K
 Beam Angle : 60°
 IP Rating : IP54

LEO-023

Powered by: **EPISTAR**



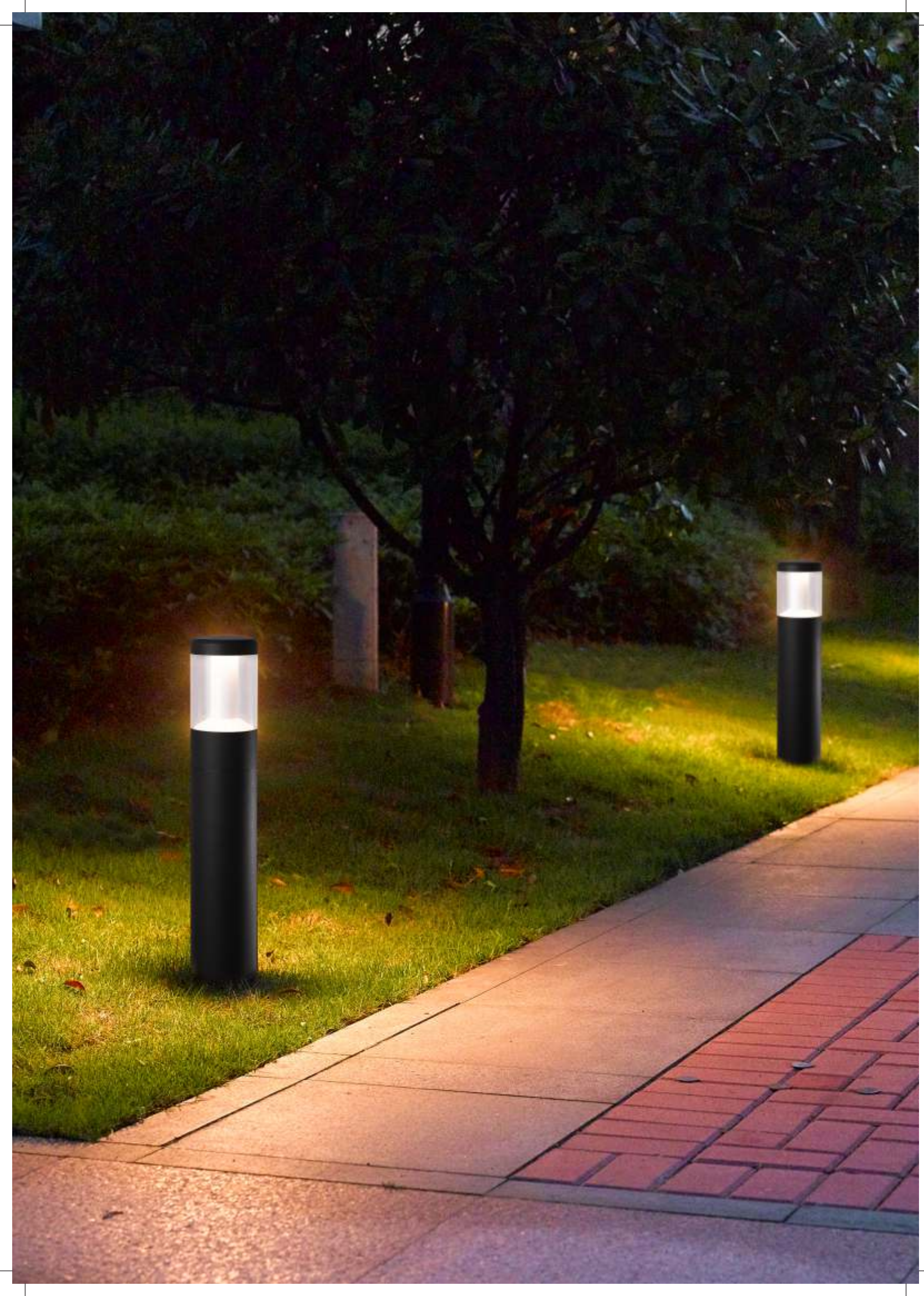

Glossary

1. lumen (lm)

Lumen is the international (SI) unit of luminous flux, a measure of overall light emitted by a light source

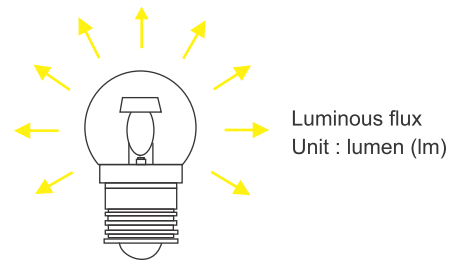

2. Candela (cd)

Candela is the international (SI) unit of luminous intensity, a measure of light emitted by a light source in a particular direction.

Any given light source will have different luminous intensities in different directions considered.

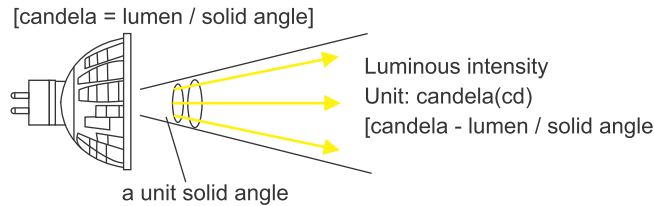

3. Beam Angle [Unit: degree]

Beam angle is the angle between two directions for which the luminous intensity is 50% of the maximum intensity as measured in a plan through the nominal beam centerline. Beam angle of a bulb gives an idea of how the light beam spreads away from the beam center.

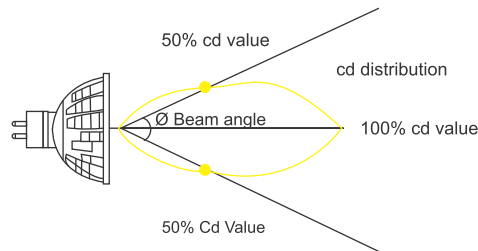

4. LUX (lx)

LUX is the international (SI) unit of luminance, a measure of light arriving at a surface, 1 lumen per square foot equals 1 foot-candle, while 1 lumen per square meter equals 1 lux.

[lux = lumen/m²]

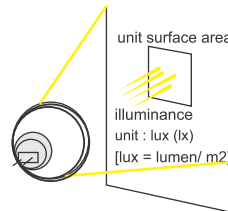

5. Color Temperature / Correlated Color Temperature (CCT)

A black-Body radiator will have a different color when it is heated up to different temperature (in Kelvin). The Temperature at which the heated black-Body radiator matches the color of the light source is the color temperature of the light source.



6. Light

Light is a term that we use to define that part of the electromagnetic radiation that humans can see ("visible light"). Visible light has a wavelength between 380 and 780nm.

7. Light Emitting Diode (LED)

A solid-state semiconductor device converting electrical energy directly into light.

8. Color Rendering Index (CRI)

Color rendering index ranges from 0-100, measures a light source's ability to reproduce the color of various objects being lit by a reference light source, black body radiator (CRI=100)

9. Luminous Flux

Measurement of perceived power of light, adjusted to reflect varying sensitivity of the human eye to different wavelengths of light.

10. Illuminance

Measurement of the intensity of light falling on a surface area.

11. Beam Component

That component of flux received directly (or by specular reflection or transmission) from a point source (such as the sun or small lamp). It is a direct component.

12. Kelvin (K)

The unit of measurement of color temperature and correlated color temperature.

13. Driver

Electronics used to power the illumination sources.

14. Ampere (Amp)

Unit of measurement for the rate of flow of electrical current.

Current (Amps) = Power (Watts) / Voltage (Volts).

15. Ambient Temperature (Ta)

Air Temperature surrounding the device.

16. Junction Temperature (Tj)

Temperature of the LED's active region.

17. Efficacy (lm/W)

Efficacy is the efficiency of a light source to convert electricity energy to light energy which is expressed in lumen output per unit power input (watt) [Efficacy = lumen / wattage]

18. Floodlighting

A system designed for lighting a scene or object to a luminance greater than its surroundings. It may be for utility, advertising or decorative purposes.

19. Dimmability

Leds are completely/fully dimmable, in fact LED life enhances when dim.

Generally led can be dimmed with PWM technique and 4 dimming protocols available in market detail below.

- A. Traic / Phase cut dimmable (Leading OR trailing edge dimmable)
- B. 1-10V Dc Analogue dimming
- C. DSI dimming Digital signal interface or can be dim via push button individual or in group.
- D. DALI dimming - Digitally address lighting interface.

20. IES

A standardized data file which expresses the light output of luminaire as luminous intensity versus angle. Derives from the acronym for the Illuminating Engineering Society of North America (IESNA). IES files are assigned the extension ".ies". Used by lighting designers to model the illumination performance of a lighting scheme using commercial lighting design software. An IES file is commonly referred to as "photometric data" for a luminaire.

21. DMX Digital Multiple X

For remote control of advance lighting systems, including motorized lamps to set light intensity, light color & lamp rotation. DMX512 (Led lighting solution) uses asynchronous data transmission up to 250kbaud/s (to Dimmers, motorized decoders). DMX protocol is never ending stream of data at 250 kb/s. Fire-and Forget communication No responses. One start Bit, Eight Data Bits, Two Stop Bits & No Parity. Led intensity control using a 120Hz PWM from 0% to 100%.

IP - Ingress Protection Ratings

Ingress Protection (IP) ratings are developed by the European Committee for Electric Technical Standardization (CENELEC) (NEMA IEX 60529 Degrees of Protection Provided by Enclosures – IP Code), specifying the environmental protection the enclosure provides.

The IP rating normally has two degrees:

- **First digit means:** Complete protection against solid objects (dust and foreign bodies)
- **Second digit means:** Protection against liquids (jets of water)

Example – IP Rating: With the IP rating IP 54, 5 describes the level of protection from solid objects and 4 describes the level of protection from liquids. An “X” can be used for one of the digits if there is only one class of protection, i.e. IPX1 which addresses protection against vertically falling drops of water e.g. condensation.

Protection against contact and foreign bodies		
IP 1 st digit	Contact	Foreign Bodies
0	No protection	No protection
1	With large parts of the body (back of the hands)	Large foreign bodies diameter greater than or equal to 50 mm
2	With a finger	Medium-size foreign bodies, diameter greater than or equal to 12 mm
3	With tools and wires, diameter greater than or equal to 2.5 mm	small foreign bodies, diameter greater than or equal to 2.5 mm
4	With tools and wires, diameter greater than or equal to 1 mm	Grain-shaped foreign bodies, diameter greater than or equal to 1mm
5	Complete protection	Dust deposit
6	Complete protection	Ingress of dust

Protection against water	
IP 2 nd digit	Water
0	No protection
1	Vertically falling drops of water
2	Obliquely falling drops of obliquely falling drops of water up to 15 ⁰ towards vertical
3	Spray water up to 60 ⁰ towards vertical
4	Splash water from all sides
5	Jets of water
6	Powerful jets of water
7	Partial immersion
8	immersion

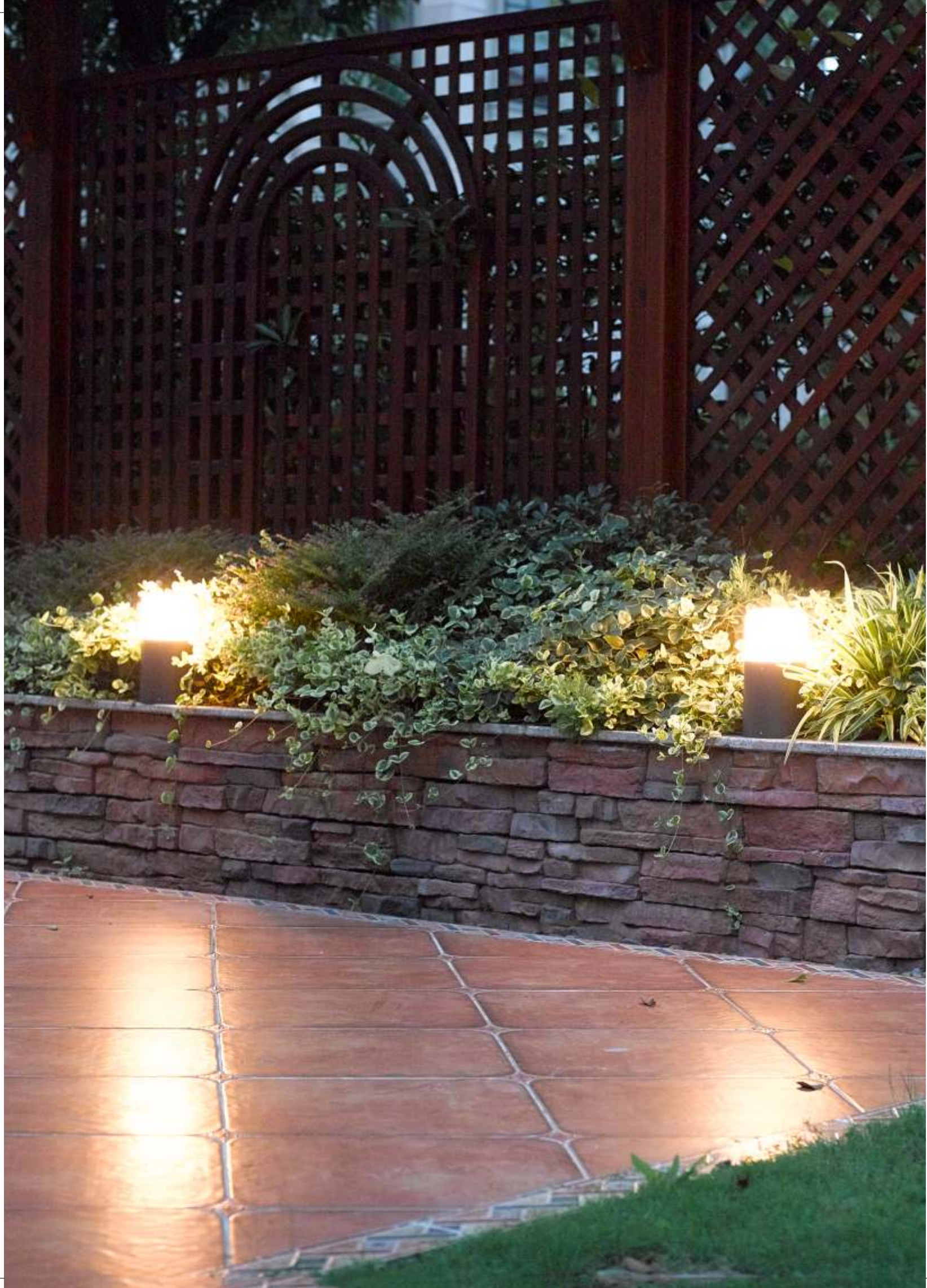

LED Lum

Lighting.Simplified



IMPORTED AND MARKETED BY:

Led Lum Lighting Solutions LLP

#77, 14th Street, South Phase, Industrial Estate, Ambattur, Chennai - 600 058.

Landline :+91 44 48528068, 48528069, Customer Care: +91 96631 02951

Email : sumeet@ledlum.in / sales@ledlum.in, Web : www.ledlum.in

